

# USER MANUAL

1700 Series Models



DIE MEISTER MACHER

Issue 06/2011

# Contents

<b>1 Components / Terminology .....</b>	<b>3</b>	<b>11 Removing / inserting the bolt .....</b>	<b>15</b>
<b>2 Introduction .....</b>	<b>4</b>	11.1 Removing.....	15
<b>3 Key to Symbols .....</b>	<b>4</b>	11.2 Inserting.....	15
3.1 General instructions .....	4	<b>12 Dismantling / assembling the bolt.....</b>	<b>16</b>
3.2 Safety instructions .....	4	12.1 Dismantling the bolt .....	16
<b>4 General handling of firearms .....</b>	<b>5</b>	12.2 Assembling the bolt.....	17
4.1 Important basics .....	5	<b>13 Trigger .....</b>	<b>17</b>
4.2 Shooting .....	6	13.1 Two stage and single-stage trigger .....	17
4.3 Maintenance .....	7	13.2 Match trigger .....	20
4.4 Transport.....	7	<b>14 Maintenance / cleaning .....</b>	<b>25</b>
4.5 Storage.....	7	14.1 General .....	25
4.6 Hearing and eye protection .....	7	14.2 Cleaning the barrel .....	26
<b>5 Legalities .....</b>	<b>7</b>	14.3 Maintenance intervals .....	27
<b>6 Intended use .....</b>	<b>7</b>	<b>15 Troubleshooting .....</b>	<b>27</b>
<b>7 Liability.....</b>	<b>8</b>	<b>16 Technical Data (model-dependent).....</b>	<b>27</b>
<b>8 Assembly and attaching the barrelled action</b>	<b>8</b>	<b>17 Disposal .....</b>	<b>28</b>
<b>9 Loading / unloading.....</b>	<b>9</b>	<b>18 Miscellaneous .....</b>	<b>28</b>
9.1 Loading .....	9	<b>19 Shooting Performance .....</b>	<b>29</b>
9.2 Unloading.....	12	<b>20 Guarantee.....</b>	<b>29</b>
<b>10 Safety catch.....</b>	<b>13</b>		
10.1 Engaging the safety catch.....	13		
10.2 Releasing the safety catch.....	14		

# 1 Components/Terminology

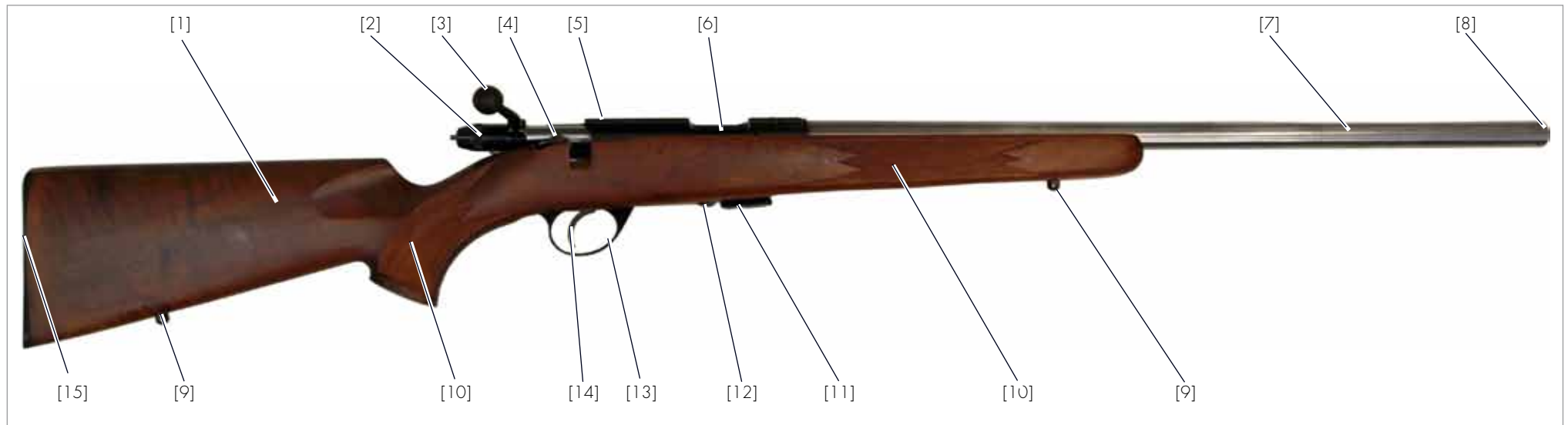

Fig.1 Overview

- |     |               |      |                     |
|-----|---------------|------|---------------------|
| [1] | Stock         | [9]  | Sling swivel eyelet |
| [2] | Bolt          | [10] | Chequering          |
| [3] | Bolt handle   | [11] | Magazine            |
| [4] | Safety catch  | [12] | Magazine holder     |
| [5] | Receiver      | [13] | Trigger guard       |
| [6] | Ejection port | [14] | Trigger             |
| [7] | Barrel        | [15] | Buttplate           |
| [8] | Muzzle        |      |                     |

## 2 Introduction

Dear hunting enthusiast,

It's important to be able to rely on the quality of a hunting rifle:

for example, exact and ever-consistent shooting performance. With an ANSCHÜTZ barrel and the detailed, well-engineered design of our bolt, you are guaranteed gunsmithing of the finest calibre. Our master builders from the Match Armoury craft hunting rifles drawing on more than 150 years' experience in the manufacture of precision rifles. But of course, tradition isn't everything. You will always be well equipped when you have an absolutely reliable, easy-to-use ANSCHÜTZ rifle.

You can always rely on a first-class ANSCHÜTZ hunting repeater. Your ANSCHÜTZ rifle will be a reliable companion with unsurpassed accuracy and function at all times.

The ANSCHÜTZ team wishes you good hunting!

## 3 Key to Symbols

In this handbook, the following symbols are used to distinguish between general information and particularly important information:

### 3.1 General instructions

- ▶ is the symbol for an instruction
- ✓ shows the desired result
- is the symbol for a list item
- ☞ is the symbol for a possible handling consequence

### 3.2 Safety instructions

- ⚠ identifies a safety instruction



#### NOTE!

An instruction indicating a specific course of action.



#### CAUTION!

Indicates a hazardous situation that can lead to minor physical injury or material damage.



#### WARNING!

Indicates a hazardous situation that can lead to serious physical injury or death.

## 4 General handling of firearms

Firearms are dangerous objects requiring the utmost care in their storage and use. The following safety and warning instructions must be observed without exception!



### NOTE!

The firearms legislation of the relevant country must be respected and complied with.

### 4.1 Important basics



### NOTE!

The use of firearms while under the influence of drugs, alcohol or medication is not permitted. Vision, dexterity and judgement can all be adversely affected.  
A good physical and mental constitution is a prerequisite for using a firearm.

- ⚠ *A firearm must only ever be used for its designated purpose.*
- ⚠ *Firearms owners are responsible for ensuring that their firearm is at no time, and especially when absent, within reach of or accessible to children or other unauthorised persons.*
- ⚠ *Firearms must not be handed over to unauthorised persons.*
- ⚠ *Only genuine ANSCHÜTZ magazines may be used.*
- ⚠ *The specified capacity of the magazines must not be exceeded.*
- ⚠ *Modifications to the rifle or the use of non-genuine ANSCHÜTZ magazines and accessories can lead to malfunctions.*
- ⚠ *Serious or life-threatening injuries and damage can be caused by the use of incorrect ammunition, by contamination in the barrel or by incorrect cartridge components.*
- ⚠ *Weapons modified in a way that could affect safety must not be used. If a fault or malfunction is detected, the weapon must be unloaded and taken to an authorised gunsmith for repair.*
- ⚠ *In the event of external effects (e.g. corrosion, being dropped, etc.), the weapon must be checked by an authorised gunsmith.*
- ⚠ *A weapon must always be treated with the utmost care and be protected from accidental damage.*

## 4.2 Shooting



### WARNING!

#### Danger to life and cause of physical damage!

Aiming the rifle at people and objects.

- When the rifle is not in use, keep the muzzle pointing in a safe direction.
- The muzzle of a firearm must never be held in a direction where it can cause damage or endanger life.



### WARNING!

#### Malfunction when shooting!

Shot not discharged after trigger pulled.

- Do not look down into the muzzle.
- Keep the muzzle of the firearm pointing in a safe direction.
- Unload the firearm.
- Remove residues from the barrel.

- ⚠ *Any firearm must be treated as if it were loaded.*
- ⚠ *Never pick up a firearm by the trigger.*
- ⚠ *Shooting galleries must be adequately ventilated.*
- ⚠ *Any bullet trap in the shooting gallery must be completely safe and visible.*
- ⚠ *No persons may stand in the vicinity of the target during a shoot.*
- ⚠ *Firearms should not be used when visibility is poor.*
- ⚠ *Do not shoot into the air, at hard or smooth surfaces, at water or at targets on the horizon.*
- ⚠ *Do not shoot at targets if the shot could ricochet or be deflected in a dangerous manner.*
- ⚠ *To prevent accidents or damage to your rifle, never hold the muzzle of a weapon that is ready to fire under water or against material or objects.*
- ⚠ *Only shoot with the calibre specified on the barrel of the rifle.*
- ⚠ *Only new, clean, factory-charged ammunition of the calibre permitted for the rifle may be used.*
- ⚠ *The ammunition must conform to the specifications of the C.I.P.*
- ⚠ *Only ever load the firearm immediately before use.*
- ⚠ *Only genuine ANSCHÜTZ magazines may be used.*
- ⚠ *The specified capacity of the magazines must not be exceeded.*
- ⚠ *Life-threatening injuries and material damage can be caused by the use of incorrect ammunition, contamination in the barrel or by incorrect cartridge components.*
- ⚠ *Only genuine ANSCHÜTZ parts may be used.*

### 4.3 Maintenance

- ⚠ *Make certain that the weapon is unloaded before and after use, and during maintenance and cleaning work.*

### 4.4 Transport

- ⚠ *Firearms may only be transported in an unloaded condition and in locked containers.*
- ⚠ *Only transport firearms in a clean, dry condition.*

### 4.5 Storage

- ⚠ *Firearms that are not in use must be kept in a secure place under lock and key.*
- ⚠ *Firearms must always be stored in an unloaded and uncocked condition.*
- ⚠ *Ammunition must be kept in a separate place under lock and key.*

### 4.6 Hearing and eye protection



#### NOTE!

**For your own safety, approved hearing and eye protection should be used when shooting! Shooting without safety equipment can result in damage to the hearing and sight.**

## 5 Legal



#### NOTE!

**The applicable firearms legislation, regulations and provisions for the respective territory, and also the safety rules of the hunting and sporting organisations must be observed.**

## 6 Intended use

The ANSCHÜTZ hunting repeating rifle 1700 is a hunting rifle. It must only be used on shoots and on shooting ranges (for sporting and hunting disciplines) and may only be used by persons who hold the appropriate firearms permit.



#### NOTE!

**A firearm must only ever be used for its designated purpose.**

## 7 Liability

ANSCHÜTZ will accept no liability or claims for compensation for damage of any kind arising from:

- failure to comply with the instructions in this user manual,
- improper treatment or repair,
- use of non-original ANSCHÜTZ parts
- incorrect handling or care,
- negligence,
- removal of the sealing lacquer,
- unauthorised tampering or
- transport damage.

	<b>CAUTION!</b>
	<b>Altering or tampering with the rifle or its parts is forbidden and may breach the terms of the guarantee. Alterations of this kind can have an adverse effect on the safe use of the product and lead to accidents that endanger life and limb. In such cases the guarantee is automatically void.</b>

 *The weapon must be checked for changes every time before it is used.*

## 8 Assembly and attaching the barrelled action

	<b>NOTE!</b>
	<b>The rifle and the action are packed separately for safety reasons and will have to be assembled.</b>

- ▶ Wipe off any excess oil from the surface of the barrelled action.
- ▶ Insert the action [2] in a cocked state (a cocked action can be identified by a red-ringed indicator pin projecting to the rear).
- ▶ Run the cleaning wick through the barrel from the chamber towards the muzzle several times.

	<b>WARNING!</b>
	<b>Danger to life!</b> Unintentional discharge as a result of a loaded, unsecured rifle. <ul style="list-style-type: none"><li>▶ Keep the muzzle of the firearm pointing in a safe direction.</li><li>▶ Engage the safety catch after loading the rifle.</li></ul>



## WARNING!

### Danger to life!

Unintentional discharge as a result of inattentiveness while engaging the safety catch or as a result of possible malfunctions after securing.

- Even when the safety catch is engaged, the muzzle of a firearm must never be pointed in a direction where it can cause damage or endanger life.



## 9 Loading/unloading

### 9.1 Loading

- ⚠ *Only ever load the rifle immediately before use.*
- ▶ Slide the magazine holder [12] forwards (in the direction of the arrow).



Fig.2 Unlocking the magazine

- ✓ The magazine [11] is unlocked and can now be removed.
- ▶ Withdraw the magazine [11] from the magazine recess by hand.

## CAUTION!

### Physical damage!

After it is unlocked, the magazine can fall out of the magazine on its own.

- Hold a hand below the magazine when unlocking it.



- ▶ Place the cartridge, base first, centrally on the loading spring (in the area with the lettering) and, using the cartridge, push the loading spring down and into the magazine (see arrows).



Fig. 3 Loading the magazine

- ✓ The magazine [11] is loaded when the cartridge rim is in contact with the rear wall of the magazine.



Fig. 4 Magazine loaded

- ⚠ **Only genuine ANSCHÜTZ magazines may be used.**
- ⚠ **The specified capacity of the magazines must not be exceeded.**
- ⚠ **Only cartridges of the calibre specified on the barrel of the rifle may be used.**
- ⚠ **Only new, clean, factory-charged ammunition of the calibre permitted for the rifle may be used.**

- ⚠ **The ammunition must conform to the specifications of the C.I.P.**



### WARNING!

#### Danger to life!

Incorrect calibre in the magazine.

- ▶ Only use the calibre specified on the barrel of the rifle.

- ▶ Insert the magazine [11] into the rifle (in the direction of the arrow) until you feel it engage.

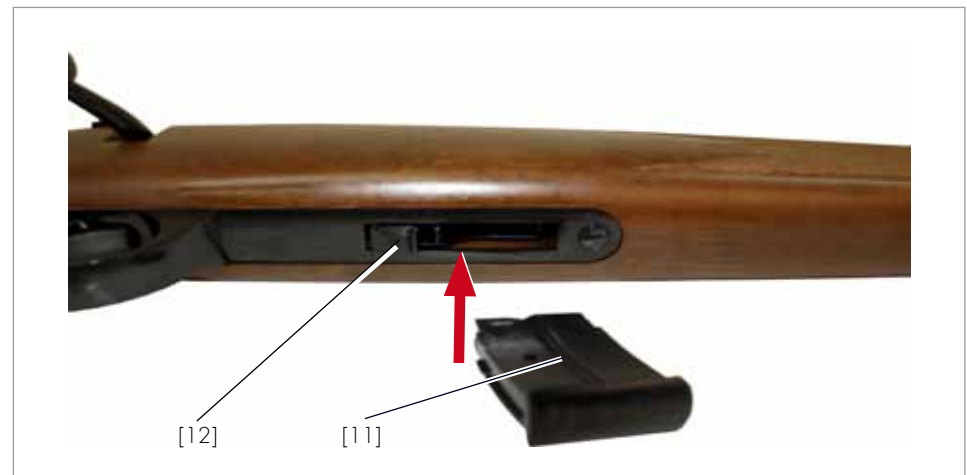

Fig. 5 Inserting the magazine

- ✓ The rifle is now loaded.
- ▶ Pivot the bolt handle [3] upwards (in the direction of the arrow).
- ✓ The firing pin is cocked.

- ▶ Open the breech [2] (pull back in the direction of the arrow to the end stop).

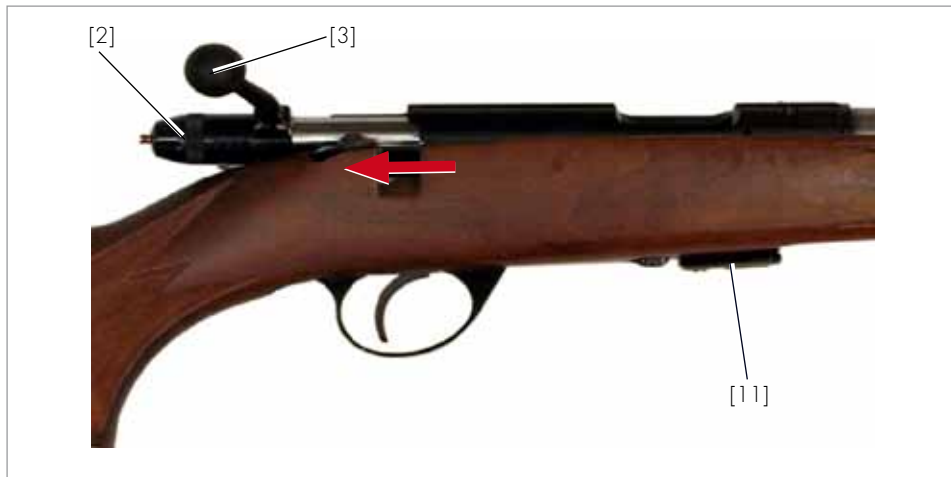

Fig.6 Opening the breech

- ✓ A cartridge is brought to the loading position from the loaded magazine [11] by opening the breech [2].
- ▶ Close the breech [2] (slide up to the stop in the direction of the arrow) and push the bolt handle [3] downwards.

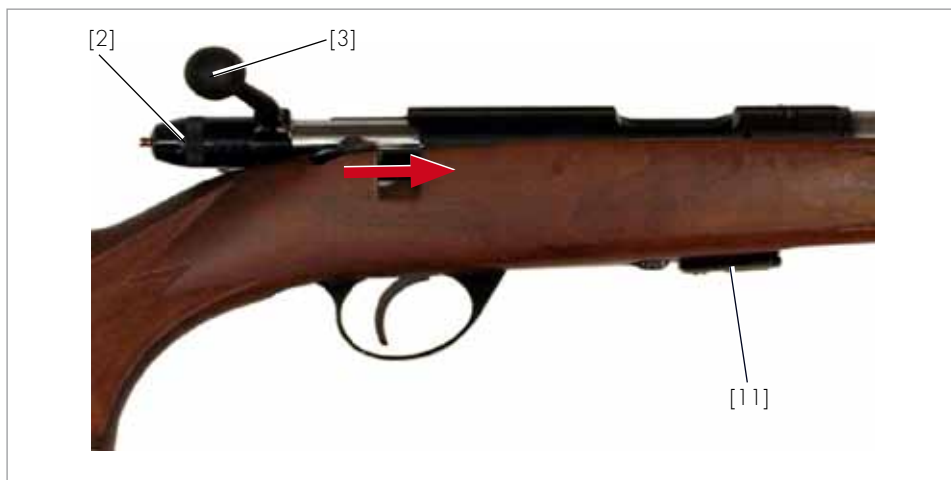

Fig.7 Closing the breech



### NOTE!

**Closing the action feeds the cartridge into the barrel.**

- ✓ The rifle is now ready to shoot (loaded and cocked).
- ▶ Engage the safety catch (see Chapter 10).



### WARNING!

#### Danger to life!

Unintentional discharge as a result of a loaded, unsecured rifle.

- ▶ Keep the muzzle of the firearm pointing in a safe direction.
- ▶ Engage the safety catch after loading the rifle.

- ✓ The rifle is fully loaded and the safety catch is engaged.



### WARNING!

#### Danger to life!

Unintentional discharge as a result of inattentiveness while engaging the safety catch or as a result of possible malfunctions after securing.

- ▶ Even when the safety catch is engaged, the muzzle of a firearm must never be pointed in a direction where it can cause damage or endanger life.

## 9.2 Unloading

- ▶ Pull the bolt handle [3] upwards.
- ▶ Open the breech [2] (pull back in the direction of the arrow to the end stop).



Fig.8 Opening the breech

- ▶ Slide the magazine holder [12] forwards (in the direction of the arrow).

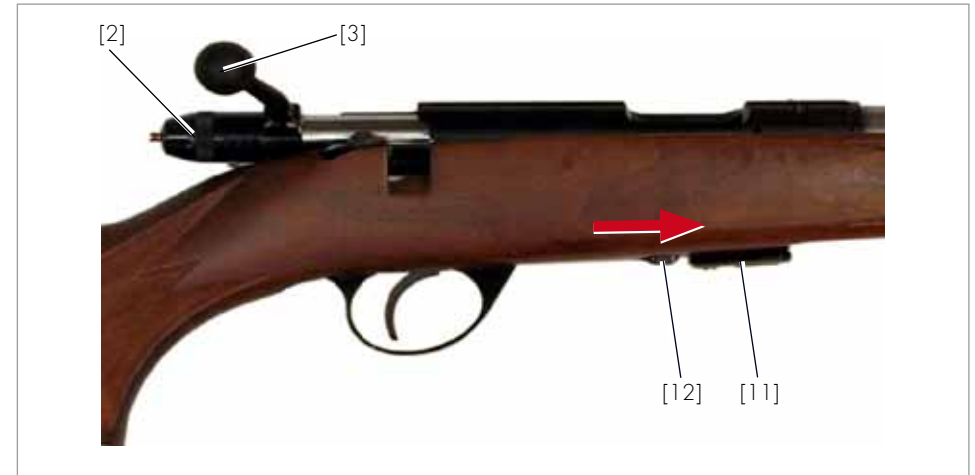

Fig.9 Sliding the magazine holder forwards

- ✓ The magazine [11] is unlocked and can now be removed.
- ▶ Withdraw the magazine [11] from the magazine recess by hand.



### NOTE!

**Any cartridge that is still in the chamber will be ejected.**



### CAUTION!

#### Physical damage!

After it is unlocked, the magazine can fall out of the magazine on its own.

- ▶ Hold a hand below the magazine when unlocking it.

- ▶ Move the safety catch [4] into the firing position (direction of arrow).

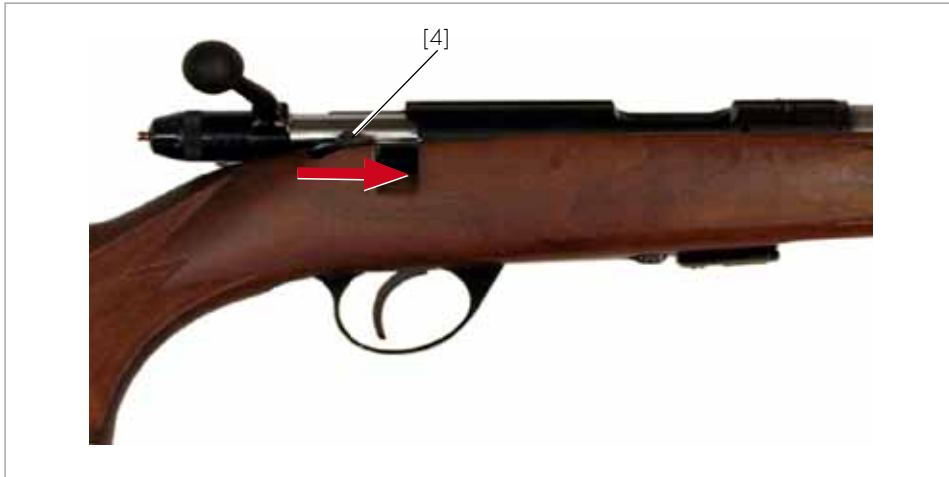

Fig.10 Sliding the safety catch forwards (releasing)

- ▶ Pull the trigger [14] and in the same sequence of actions, close the breech [2] (slide up to the stop in the direction of the arrow) and pivot the bolt handle [3] downwards.



Fig.11 Closing the breech

- ✓ The rifle is unloaded and uncocked.

## 10 Engaging /releasing the safety catch



### NOTE!

The safety catch can only be engaged/released when the rifle is cocked. The following describes the general procedure "releasing/setting the safety catch".

### 10.1 Engaging the safety catch

- ▶ Slide the safety catch [4] to the rear (direction of arrow).

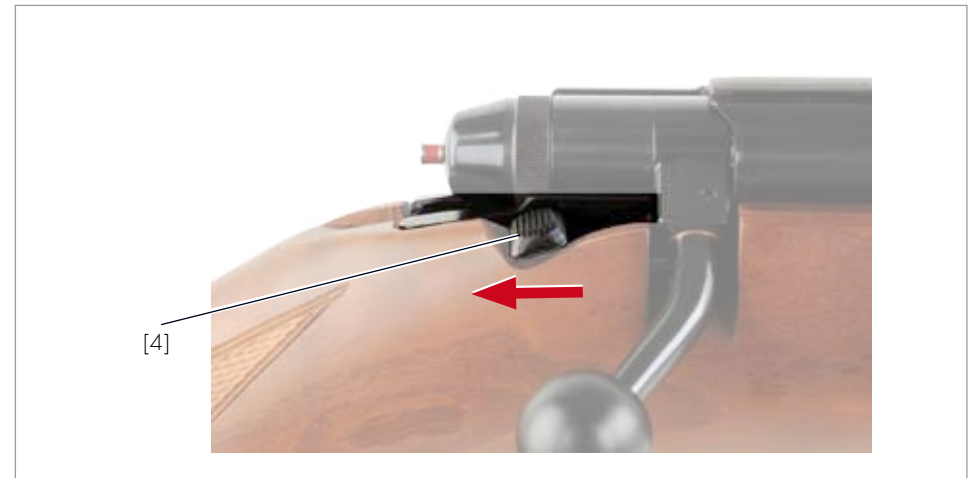

Fig.12 Sliding the safety catch back

- ✓ The rifle is cocked and the safety catch is engaged.

## 10.2 Releasing the safety catch

- ▶ Close the breech [2].



Fig. 13 Closing the breech

- ▶ Pivot the bolt handle [3] downwards (direction of arrow).

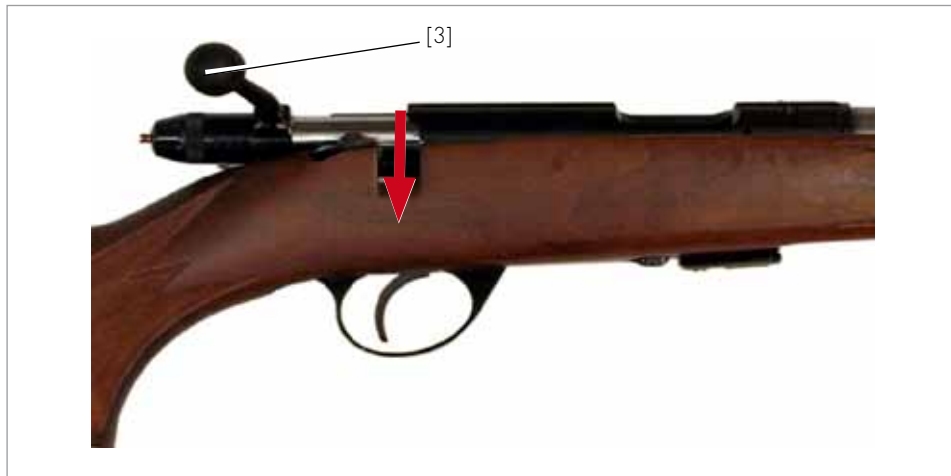

Fig. 14 Pivoting the bolt handle downwards

- ✓ The rifle is cocked and locked.

- ▶ Move the safety catch [4] into the firing position (direction of arrow).

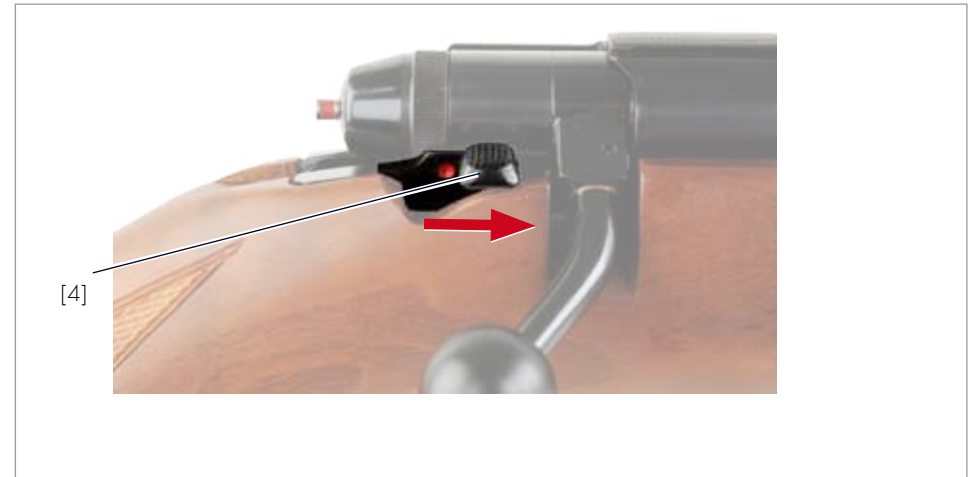

Fig. 15 Safety catch "Ready to Fire"

- ✓ The rifle is cocked and the safety catch is released.

## 11 Removing/inserting the bolt

### 11.1 Removing

- ▶ Open the bolt. Press the bolt release lever [z] and simultaneously pull the bolt [2] out of the receiver [7] (in the direction of the arrow).



Fig.16 Removing the bolt

### 11.2 Inserting

- ▶ Cock the bolt [2] (by turning the bolt handle against the bolt).
- ▶ Bring the bolt [2] up to the receiver [5] (with the guide slot facing downwards) while pressing the bolt release lever [z], and push the bolt [2] forwards to the stop until it engages (direction of arrow).



Fig.17 Inserting the bolt

- ✓ The bolt is inserted.



#### NOTE!

The bolt [2] can only be pushed into the receiver [7] when it is cocked.

## 12 Dismantling / assembling the bolt

### 12.1 Dismantling the bolt

- ▶ Remove the bolt [2] (see Chapter 11.1).
- ▶ Uncock the bolt [2] (turn the bolt handle [g] counter-clockwise in the direction of the arrow).
- ✓ The indicator pin [c] which protrudes in the cocked state retracts completely into the bolt.

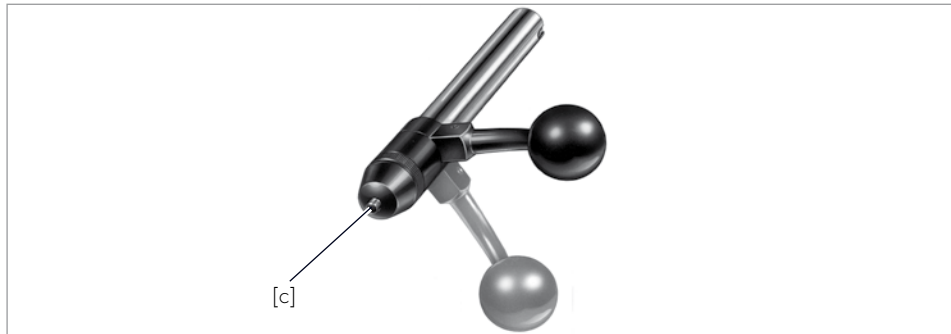

Fig. 18 Indicator pin

- ▶ Unscrew the rear cap [a].



#### NOTE!

A "ratchet noise" can be heard during the first few rotations.

- ☞ All the other bolt parts can be removed in sequence.
- ▶ Slide the front spring support back to the stop and turn slightly to the right or left (approx.  $\frac{1}{4}$  turn).
- ✓ The front spring support, together with the compression spring,

can be pulled off to the front from the firing pin [f].

- ▶ Pull out the firing pin with compression spring [f].
- ✓ The bolt [2] is now dismantled and can be cleaned.

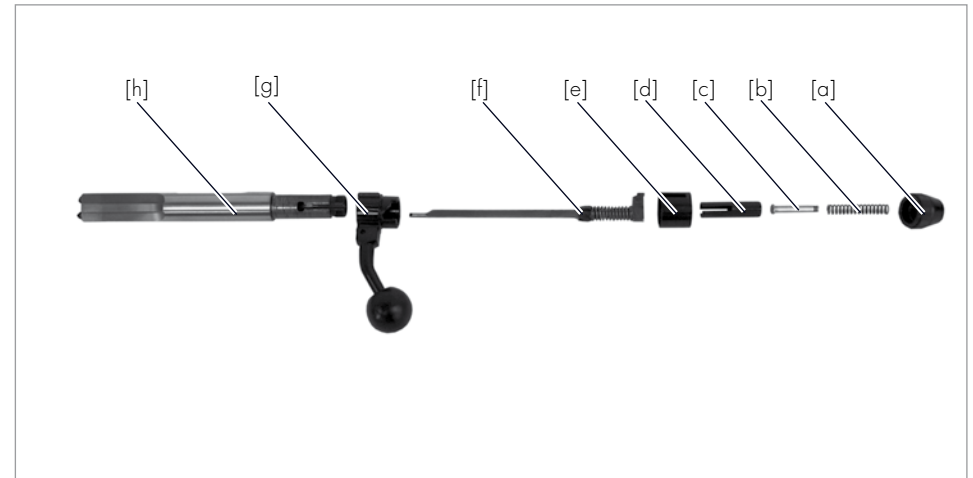

Fig. 19 Dismantled bolt

#### Key to illustration

- a Cap
- b Compression spring
- c Indicator pin
- d Rear spring support
- e Cover sleeve
- f Firing pin with compression spring
- g Bolt handle
- h Chamber



## 12.2 Assembling the bolt

- ▶ First slide the compression spring for the firing pin [f] over the firing pin [f], followed by the front spring support [g].
- ▶ Slide the front spring support back to the stop and turn slightly to the right or left (approx.  $\frac{1}{4}$  turn). Then allow to click in place.
- ▶ Hold the chamber [h] vertically.
- ▶ Place the bolt handle [g] on to the end of the chamber and rotate with respect to each other (the lowest point of the sloping cocking cam on the bolt handle [g] and the longitudinal slot of the end of the chamber must be in line).
- ▶ Insert the complete firing pin with compression spring [f] and the front spring support, point first, into the chamber [h] so that its lug penetrates into the longitudinal slot.
- ▶ Place the cover sleeve [e] and rear spring support [d] (slot openings must face forwards) on to the rear end of the chamber (the lugs on these parts which face inwards or outwards must engage with the longitudinal slot on the chamber [h]).
- ▶ Insert the indicator pin [c] and compression spring [b].
- ▶ Screw cap [a] in position.

### NOTE!

**Before inserting the assembled action in the receiver, the action needs to be cocked again by forceful tilting to the left or the right (by twisting the bolt handle [h] against the action).**

## 13 Trigger

### 13.1 Two stage and single stage trigger

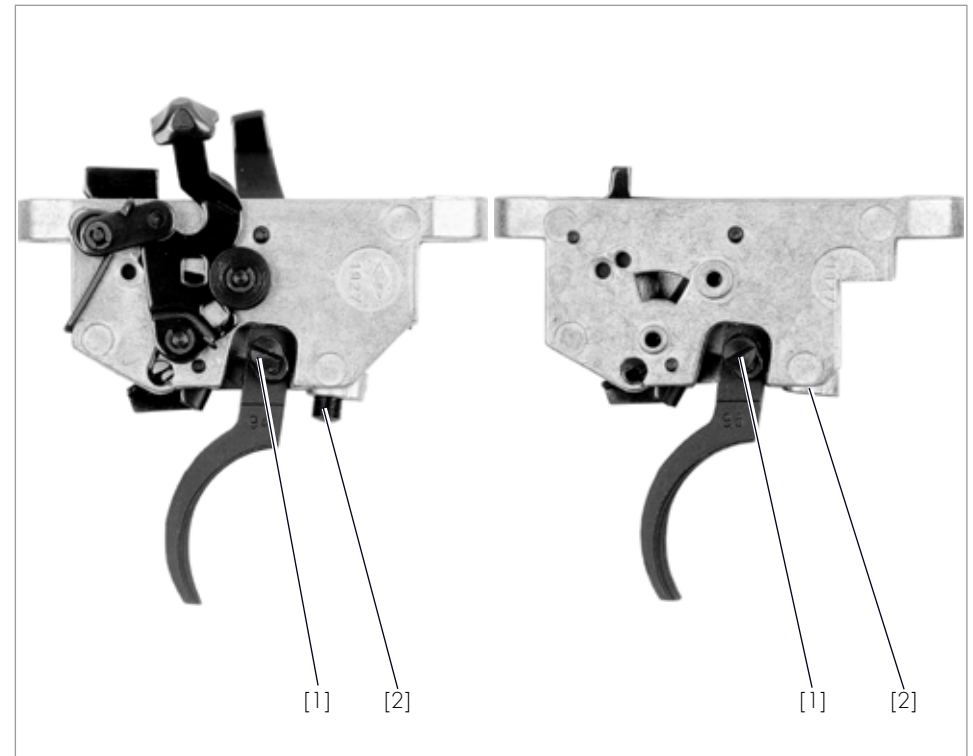



Fig.20 Trigger

### Key to illustration

- 1 Adjusting screw for sear engagement (factory setting!)
- 2 Trigger weight adjusting screw

	<b>WARNING!</b>
	<p><b>Danger to life!</b></p> <p>Danger to life from loaded firearm.</p> <ul style="list-style-type: none"> <li>➤ Do not look down into the muzzle.</li> <li>➤ Keep the muzzle of the firearm pointing in a safe direction.</li> </ul>
	<b>CAUTION!</b>
<p><b>Material damage!</b></p> <p>Damage to the trigger caused by the breech not being open when the trigger is changed.</p> <ul style="list-style-type: none"> <li>➤ Open the breech when changing the trigger.</li> </ul>	

## 1 Trigger weight

Adjusting the trigger weight by means of trigger weight adjusting screw [2]:

- turn clockwise = trigger weight is increased (+)
- turn anticlockwise = trigger weight is reduced (-)

The trigger and first stage weights are mechanically interdependent. Any adjustment always results in a small concurrent change in the trigger or first stage weight.

	<b>WARNING!</b>
	<p><b>Danger to life!</b></p> <p>Unintentional discharge as a result of too short a sear engagement and/or too low a trigger weight.</p> <ul style="list-style-type: none"> <li>➤ Do not set the sear engagement too short.</li> <li>➤ Do not set the trigger weight too low.</li> <li>➤ Do not subject loaded and unsecured rifles to impact and do not use force to close the breech.</li> </ul>

## 2 Sear engagement with two-stage trigger

The sear engagement denotes the travel from the second stage to the release of the trigger.

Adjusting the sear engagement on a two-stage trigger by means of the sear engagement adjusting screw [1]:

- turn anticlockwise = sear engagement is shortened
- turn clockwise = sear engagement is lengthened

### Setting the optimum sear engagement:

⚠ **The rifle must be unloaded.**

- ▶ Cock the rifle and release the trigger (check whether the trigger releases as desired).

### The sear engagement on the two-stage trigger is too long:

There is a short travel from the second stage to the release of the trigger (so-called "pull" or "tug").

- ▶ After cocking and releasing the trigger, turn the sear engagement adjusting screw [1] anti-clockwise in steps (approx.  $\frac{1}{8}$  turn each time).
- ▶ Repeat the procedure until the second stage is no longer perceptible.
- ▶ Then turn back  $\frac{1}{2}$  turn clockwise.
- ✓ The optimum sear engagement is now set.

### The sear engagement on the two-stage trigger is too short:

There is no longer any second stage. The trigger releases indefinitely without a second stage.

- ▶ After cocking, turn the sear engagement adjusting screw [1] at least  $\frac{1}{4}$  turn clockwise, release the trigger and check whether there is a second stage.
- ▶ If not, repeat the procedure until there is a perceptible second stage.
- ▶ As soon as there is a perceptible second stage, proceed according to the subsection "If the sear engagement is too long" to achieve the optimum sear engagement.

### Setting the optimum sear engagement with single stage trigger:

- ▶ Cock the trigger
- ▶ Turn trigger weight adjusting screw [2] (second stage) clockwise until the trigger releases.
- ▶ From this setting, turn trigger weight adjusting screw [2] approx.  $\frac{1}{2}$  turn anti-clockwise.



### WARNING!

#### Danger to life from automatic firing!

Automatically firing shots and malfunctions caused by minimally set trigger weight and too short a sear engagement.

- ▶ Do not set the trigger weight too low.
- ▶ Do not set the sear engagement too short.

### 3 Trigger malfunctions caused by misadjustment

Proceed as follows in the event of malfunctions caused by a misadjusted trigger:

- ▶ The trigger function must be checked after every change.
- ▶ When the malfunction has been rectified, check the desired trigger characteristic and adjust it again if necessary.

#### The trigger catches the firing pin but does not fire when pulled:

- Check whether the safety catch is engaged.

#### The trigger is not catching the firing pin (single stage trigger set too tight):

- Turn the sear engagement [2] approx. 1–2 turns anti-clockwise and then proceed as per "Sear engagement with two-stage trigger is too long".

## 13.2 Match trigger

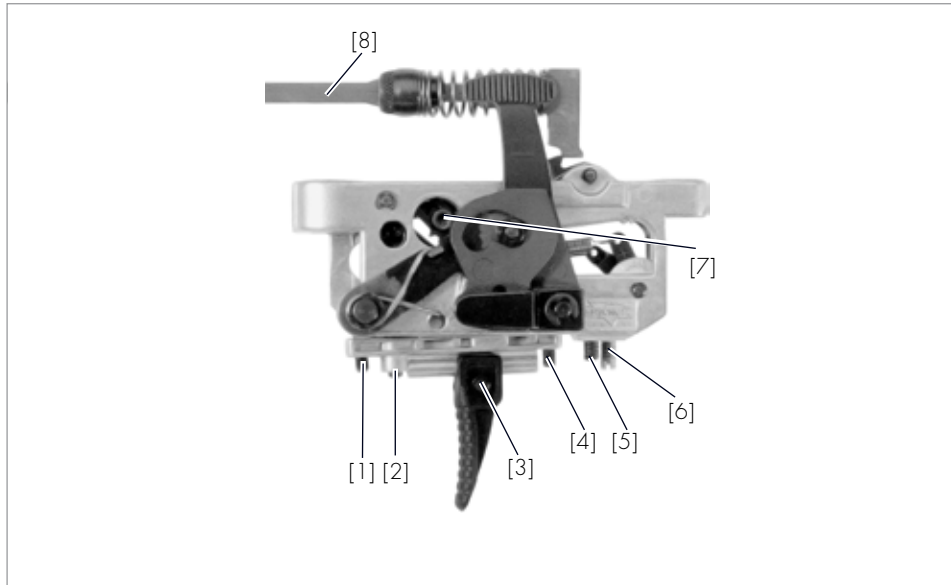

Fig. 21 Match trigger

### Key to illustration

- 1 First stage adjusting screw
- 2 Second stage adjusting screw
- 3 Trigger blade
- 4 Trigger stop adjusting screw
- 5 First stage pull adjusting screw
- 6 Trigger weight adjusting screw
- 7 Trigger cam
- 8 Firing pin



### WARNING!

#### Danger to life!

Danger to life from loaded firearm.

- Make sure that the rifle is unloaded when carrying out alignment and adjustment procedures.



### CAUTION!

#### Physical damage!

Damage to the trigger caused by the breech not being open when the trigger is changed.

- Open the breech when changing the trigger.

### 1 Trigger weight

Adjusting the trigger weight by means of adjusting screw [6]:

- turn clockwise = trigger weight is increased (+)
- turn anticlockwise = trigger weight is reduced (-)

The trigger and first stage weights are mechanically interdependent. Any adjustment always results in a small concurrent change in the trigger or first stage weight.

#### Moving the trigger cam

- lowest setting of cam = lowest trigger weight
- highest setting of the cam = highest trigger weight



## NOTE!

**A 2 mm Allen key and maybe tweezers will be needed to adjust the trigger cam.**

- turn anticlockwise = loosen fixing screw
- turn clockwise = tighten fixing screw

After the trigger cam has been moved it will be necessary to check the sear engagement (according to the subsection "Sear engagement") and readjust it if necessary.

Fine adjustments are made to the trigger and first stage weights by means of adjusting screws [6] (trigger weight) and [5] (first stage weight).



## CAUTION!

### Physical damage!

Risk of fracturing the clamping screw with too high a torque.

- Ensure that the trigger cam is correctly seated.

## 2 First stage pull with two-stage trigger

Adjusting the first stage weight by means of adjusting screw [5]:

- turn clockwise = first stage weight is increased (+)
- turn anticlockwise = first stage weight is reduced (-)

The trigger and first stage weights are mechanically interdependent. Any adjustment always results in a small concurrent change in the trigger or first stage weight.

## WARNING!



### Danger to life!

Unintentional discharge as a result of too short a sear engagement and/or too low a trigger weight.

- Do not set the sear engagement too short.
- Do not set the trigger weight too low.
- Do not subject loaded and unsecured rifles to impact and do not use force to close the breech.

## 3 Sear engagement with two-stage trigger

The sear engagement denotes the travel from the second stage to the release of the trigger.

Adjusting the optimum sear engagement on a two-stage trigger by means of adjusting screw [1]:

- turn clockwise = sear engagement is shortened
- turn anticlockwise = sear engagement is lengthened

Setting the optimum sear engagement:

⚠ ***The rifle must be unloaded.***

- Cock the rifle and release the trigger (check whether the trigger releases as desired).

### The sear engagement on the two-stage trigger is too long:

There is a short travel from the second stage to the release of the trigger (so-called "pull" or "tug").

- ▶ After cocking and releasing the trigger, turn adjusting screw [2] clockwise in steps (approx.  $\frac{1}{8}$  turn each time).
- ▶ Repeat the procedure until the second stage is no longer perceptible.
- ▶ Then turn back  $\frac{1}{4}$  turn anticlockwise.
- ✓ The optimum sear engagement is now set.

### The sear engagement on the two-stage trigger is too short:

There is no longer any second stage. The trigger releases indefinitely without a second stage.

- ▶ After cocking, turn the adjusting screw [2] at least  $\frac{1}{4}$  turn anticlockwise, release the trigger and check whether there is a second stage.
- ▶ If not, repeat the procedure until there is a perceptible second stage.
- ▶ As soon as there is a perceptible second stage, proceed according to the subsection "If the sear engagement is too long" to achieve the optimum sear engagement.

To set the sear engagement with a single-stage trigger using adjusting screw [2], see Point 7.

## 4 First stage travel with two-stage trigger

First stage travel denotes the travel of the trigger blade from the zero position to the second stage.

Setting the first stage travel by means of adjusting screw [1]:

- turn clockwise = first stage travel is shortened
- turn anticlockwise = first stage travel is lengthened

	<b>WARNING!</b>
	<b>Danger to life!</b> The first stage travel adjusting screw is set beyond the second stage function. <ul style="list-style-type: none"><li>▶ Never turn the first stage travel adjusting screw beyond the second stage function.</li><li>▶ Never remove the first stage travel completely in order to convert the two-stage trigger to a single stage trigger.</li></ul>

## 5 Trigger stop

The trigger stop denotes the travel from the second stage to the end stop for the trigger blade.

Setting the trigger stop by means of the trigger stop adjusting screw [4]:

- turn clockwise = trigger stop is shortened
- turn anticlockwise = trigger stop is lengthened

	<b>CAUTION!</b>
	<b>Malfunction!</b> Trigger stop adjusting screw has been turned beyond the actuation point (trigger does not actuate). ➤ Do not turn the trigger stop adjusting screw in beyond the actuation point.

## 6 Moving the trigger blade

Release clamping screw [3]. The trigger blade can both be moved along the guide and also pivoted to the side.

## 7 Converting a two-stage trigger to a single stage trigger

Adjustments:

- Turn the screw for the first stage travel [1] anticlockwise until the maximum first stage length has been set.
- Cock
- Turn adjusting screw [2] (second stage) anticlockwise until the trigger releases.
- From this setting, turn adjusting screw [2] approx.  $\frac{1}{4}$  turn clockwise.
- ✓ The trigger is now adjusted for single stage; there is no longer any first stage travel.

	<b>WARNING!</b>
	<b>Danger to life from automatic firing!</b> Automatically firing shots and malfunctions caused by minimally set trigger weight and too short a sear engagement. ➤ Do not set the trigger weight too low. ➤ Do not set the sear engagement too short.

## 8 Converting a single stage trigger to a two-stage trigger

- Turn the trigger stop adjusting screw [4] approx.  $2\frac{1}{2}$  turns anticlockwise (set the max. trigger stop longer).
- Release the safety catch and cock the rifle.
- Turn adjusting screw [2] clockwise by approx.  $2\frac{1}{2}$  turns.
- ✓ The second stage is now perceptible.

⚠ *To set the optimum sear engagement, the procedure in Chapter 3 ("Setting the optimum sear engagement") must be followed.*

- ▶ If required, the trigger characteristics can be set to the desired values as follows: first stage travel per Point 4, trigger stop per Point 5, trigger weight per Point 1 and first stage weight per Point 2.

## 9 Trigger malfunctions caused by misadjustment

Proceed as follows in the event of malfunctions caused by a misadjusted trigger:

- ▶ The trigger function must be checked after every change.
- ▶ When the malfunction has been rectified, check the desired trigger characteristic and adjust it again if necessary.

**The trigger catches the firing pin but does not fire when pulled:**

- Check whether the safety catch is engaged.
- Check that the trigger cam [7] is present and screwed on correctly.
- The trigger stop adjusting screw [4] is screwed in a few turns too far (turn screw [4] anticlockwise by a few turns until the firing pin [8] releases once more when the trigger is pulled).

**The trigger does not catch the firing pin:**

- Adjusting screw [1] (first stage) is screwed in several turns too far.
- Check that the tension spring is not damaged and is fitted correctly.

**The single stage trigger is set too tight:**

- Turn adjusting screw [2] clockwise in  $\frac{1}{4}$  turn steps until the firing pin [8] is caught.

**The catch link return spring is too weak or is defective:**

- The trigger must be returned to the factory for repair.



## 14 Maintenance / cleaning

### 14.1 General



#### WARNING!

##### Danger to life!

Danger to life from loaded firearm.

- Ensure that the rifle is unloaded before use or during maintenance and cleaning work.



#### CAUTION!

##### Injury and material damage!

Danger of injury or material damage as a result of not removing the oil from the barrel and chamber.

- Each time before shooting, any oil or foreign objects must be removed from the barrel and chamber.



#### CAUTION!

Always look out for any changes or damage that may occur to the rifle.

In the event of a change or damage, the rifle must immediately be taken to an authorised gunsmith or sent to ANSCHÜTZ for inspection.



#### NOTE!

After each use of the rifle, apply a thin film of oil to the steel parts and thoroughly clean the barrel.

When the rifle is transported from cold to warm rooms, condensation can form on the metal parts and inside the barrel. If this condensation is not quickly dried off, it can possibly lead to surface rust.

No other aids (felt plugs, non-approved grease, etc.) should be used for cleaning the barrel.



### NOTE!

The rifle should be protected from dust, sand, moisture, heat and damaging influences.



### NOTE!

The rifle case / soft case should be cleaned regularly and any dust and fluff removed.

Rifle cases and soft cases should have a smooth, dust-repellent lining.

When not in use, the rifle case / soft case should always be left open to allow moisture to escape. Enclosing a desiccant can reduce the moisture content.

## 14.2 Cleaning the barrel

If the barrel is only slightly dirty, use a plastic brush to clean it.

- ▶ Oil the plastic brush lightly and push it through the barrel from the chamber end using a clean cleaning rod.



Fig.22 Plastic brush

If the barrel is very dirty, use a bronze brush together with a suitable barrel cleaner.



### NOTE!

Pay attention to the user instructions for the cleaner!



Fig.23 Bronze brush

- ▶ Pull a woollen swab through the barrel several times to dry it.



### NOTE!

It is essential to re-oil the barrel after using ammonia-containing cleaning agents, to avoid the risk of corrosion.

## 14.3 Maintenance intervals



### NOTE!

Pay attention to the instructions supplied with the cleaner.

### Before shooting

- Carefully remove any oil from the rifle.
- ⚠ *The de-oiling of the rifle should be carried out at room temperature, as too many residues can be left in the barrel if it is very cold.*

### After shooting

- Oil the rifle (including the stock) with a suitable gun oil.
- Clean the barrel with a plastic brush and gun oil.

### With severe contamination

- Clean the barrel with a bronze brush and a suitable barrel cleaner.
- Wipe the rifle (including the stock) with an oily rag.

### Yearly

- Take the rifle to a dealer/gunsmith for inspection.

## 15 Troubleshooting



### WARNING!

In the event of malfunctions (e.g. shots not discharged, etc.) the rifle must be unloaded, secured and taken without delay to a specialist dealer/gunsmith or sent to ANSCHÜTZ.

## 16 Technical Data (model-dependent)

Weight	3.3 – 3.6 kg
Overall length	104 – 107.5 cm
Barrel length	54.9 – 58.4 cm
Rifling	54.9 – 58.4 cm
Version	Repeater
Calibre	.22 l.r



### NOTE!

The technical data refers to the complete model range. Specific model data can be obtained at [www.anschuetz-sport.com](http://www.anschuetz-sport.com).

## 17 Disposal

Disposal of the rifle must be carried out and certified by a specialist dealer or gunsmith.



## 18 Miscellaneous

Additional information is available on the Internet at [www.anschuetz-sport.com](http://www.anschuetz-sport.com).

The original group for your rifle at 50m is affixed to the CD case.

[www.anschuetz-sport.com](http://www.anschuetz-sport.com)

## 18 Shooting Performance

The shooting precision of a rifle depends on several factors. One very important factor in this respect is the ammunition. Not every barrel shoots with the same efficiency. Considerable performance differences are apparent with each ammunition type. The target sight and its mount are just as important. Parallax, loose reticle, faulty reticle adjustment and inappropriate mount are the most frequent causes of poor shooting performance. As such, only brand-name telescopic sights and mounts should be used and the ammunition matched to your rifle. Even ammunition from the same manufacturer and the same batch can, from one production run to another, and from one rifle to another, result in varying shooting performance and hitting accuracy. When the most suitable ammunition, target sights and mount have been selected we can guarantee the excellent shooting performance of our weapons. See warranty card.

## 19 Guarantee

### <<< WARRANTY >>>

**1. Material:** This product has been released for sale after the product itself, its materials and individual components have been subjected to strict inspection, or the rifle has demonstrated its durability and function during test shooting. J.G. ANSCHÜTZ GmbH & Co. KG offers a full guarantee covering material and manufacturing faults (excluding broken stocks and springs) for a period of two years, provided that the fault can be shown to have been present at the time of handover of the product. No warranty claims will be accepted by J.G. ANSCHÜTZ GmbH & Co. KG for faults that are the result of improper use or unauthorised repairs. The item will either be repaired or replaced at our discretion. Claims for compensation - put forward for any legal reason whatsoever - are excluded.

**2. Shooting Performance:** The purchaser undertakes to inform J.G. ANSCHÜTZ GmbH & Co. KG in writing of any faults detected in shooting performance within one month of purchase with the submission of their own shooting record. J.G. ANSCHÜTZ GmbH & Co. KG reserves the right to transfer the rifle to an independent agency for inspection (DEVA or a national ballistics office). Should such an agency confirm excellent shooting performance, J.G. ANSCHÜTZ GmbH & Co. KG is entitled to charge the purchaser the costs of the rifle inspection. The accepted warranties do not apply to rifle damage resulting from mechanical effects and improper use or care by the purchaser. The warranty is excluded if the rifle has been repaired or modified by unauthorised persons. Likewise, the warranty is cancelled when using reloaded ammunition or ammunition which is not CIP approved.

In the event of a warranty/damage claim please enclose this card, completed and signed by your dealer, with the product.

J.G. ANSCHÜTZ GmbH & Co. KG · Jagd- und Sportwaffenfabrik  
Postfach 1128 · D-89001 Ulm/Germany · [www.anschuetz-sport.com](http://www.anschuetz-sport.com)



SERIAL-NO.: \_\_\_\_\_

DATE: \_\_\_\_\_

THIS ITEM WAS BOUGHT FROM: *(Stamp and signature of dealer)*