

NVMD



Day Night Technologies

User Manual

NVMD-C200

Night Vision Multi-Purpose Device

Note: To ensure the best experience, please keep your firmware up to date. Some updates may not yet be reflected in this manual.

For the latest User Manual and firmware updates, please visit
dntoptics.com

Contents

| | |
|---|-----------|
| READ BEFORE USE | 1 |
| Safety Instructions..... | 1 |
| Power Supply | 1 |
| Package Contents..... | 1 |
| Glossary | 2 |
| INTRODUCTION | 3 |
| Features..... | 3 |
| Device Overview | 4 |
| On-Screen Display..... | 5 |
| Specifications..... | 7 |
| Download the DNT App..... | 8 |
| START USING | 9 |
| Installing Battery..... | 9 |
| Quick Start..... | 10 |
| Menu Navigation | 11 |
| Diopter and Focus Adjustments..... | 12 |
| Zeroing NVMD | 13 |
| ■ Zeroing Menu..... | 13 |
| ■ Zeroing in Scope Mode..... | 14 |
| ■ Zeroing in Clip-On Mode..... | 15 |
| FUNCTIONS..... | 16 |
| Power | 16 |
| ■ Powering On/Off NVMD | 16 |
| ■ Standby Mode..... | 16 |
| ■ Auto Power-Off | 17 |
| Display | 17 |

| | |
|--|-----------|
| ■ Adjusting Screen Brightness | 17 |
| ■ Zooming In/Out | 17 |
| ■ Switching Image Modes | 18 |
| ■ Picture in Picture (PIP) | 18 |
| Recording | 19 |
| ■ Recording Start/End | 19 |
| ■ Loop Recording | 19 |
| ■ Recoil Activated Video (RAV) | 20 |
| ■ Audio Recording | 20 |
| Sight Modes | 21 |
| ■ Scope Mode | 21 |
| ■ Clip-On Mode | 21 |
| ■ Magnifier Mode | 22 |
| ■ Flip-to-side Action Camera (Only with QDF-170) | 22 |
| ■ Flip-initiated Standby (Only with QDF-170) | 23 |
| Peripherals | 24 |
| ■ Gyroscope Function & Calibration | 24 |
| ■ Compass Function & Calibration | 25 |
| Connections | 27 |
| ■ Connecting to the DNT App | 27 |
| ■ Managing Recorded Videos via the DNT App | 28 |
| ■ USB-C Connection | 30 |
| APPENDIX | 31 |
| Table of Controls | 31 |
| Table of Menus | 32 |
| FCC WARNING | 34 |

READ BEFORE USE

Safety Instructions

- Device Operating Temperature: –20 to 50°C (–4 to 122°F)
- Device Storage Temperature: –20 to 60°C (–4 to 140°F)
- **DO NOT** attempt to disassemble the device. Please contact us if there is any malfunction.

Power Supply

NVMD is powered by an external 18650 battery and provides up to 6 hours of operation. When the battery is low, it must be replaced. A 5-volt USB-C external power source can also be used to power the device directly.

Note: NVMD does not support charging the battery via the USB-C port. To charge the battery, please use an external battery charger.

Package Contents

| | |
|----------------------|----------------------|
| NVMD-C200 × 1 | Microfiber Cloth × 1 |
| DNT QDS-150 × 1 | Rubber Lens Cap × 1 |
| USB-C Data Cable × 1 | NVMD Quick Start × 1 |
| NVMD User Manual × 1 | |

Glossary

Long-press: Press and hold the button for 2 seconds.

Bolded Controls: Control instructions are marked in **bold** for easier reading. (e.g. **Menu Button**)

[Menu Items]: Menu items are enclosed in square brackets to indicate menu navigation steps clearly.

Menu navigation steps are shown in the following format:

[Main Menu] > [Reticle Settings] > [Reticle Colors] > [Red]

This means you first select [Reticle Settings] from the [Main Menu], then choose [Reticle Colors], and finally select [Red].

Live View: Refers to the main screen where live video is displayed. It is the default screen NVMD enters when powered ON.

Menu: Refers to the screen where menu items are displayed, including the main menu and sub-menus. The live video remains visible in the background while navigating the menus.

INTRODUCTION

NVMD-C200 (Night Vision Multi-Purpose Device) is a compact and versatile digital scope built for 24/7, all-weather operation in any environment. Its 4-in-1 multi-purpose design enables it to function as a red dot magnifier, standalone scope, clip-on, or action camera.

Features

- **4-in-1 Multi-Mode Functionality**

Functions as a red dot magnifier, standalone scope, clip-on, or action camera.

- **Large Sensor Area with Big Pixel CMOS**

Delivers superior imaging performance in ultra-low-light conditions.

- **F1.2 Large Aperture with 1x Base Magnification**

Maximizes light intake and works with the CMOS sensor for enhanced night vision.

- **65 mm / 2.6 in Eye Relief & Generous Eyebow**

Ensures comfortable and flexible viewing, even during extended use.

- **27.0° × 15.4° Ultra-Wide Field of View (FOV)**

Provides a broad, immersive view for faster target tracking.

- **Built-in 32 GB eMMC Storage**

Enables instant video recording without external memory cards.

- **App Connectivity**

Connects to the DNT App for real-time viewing and recording management.

- **Flip-initiated Features**

*Supports Auto Standby or Auto Recording when flipped. (Only with DNT QDF-170 Quick Detach Flip Mount - **SOLD SEPARATELY**)*

Device Overview

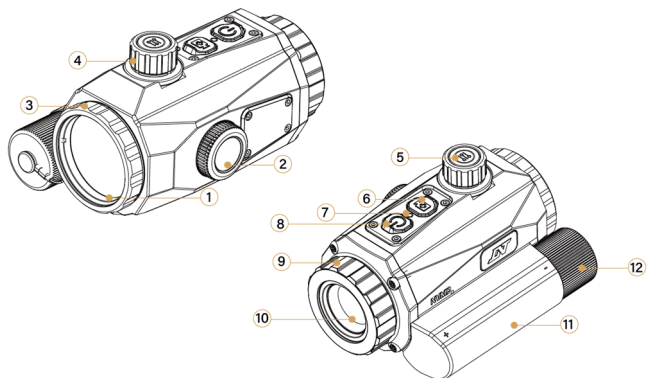

| | |
|----------------------------|--------------------------|
| 1. Ocular Lens | 7. Power Indicator |
| 2. USB-C Port Cap | 8. Power Button |
| 3. Diopter-adjustment Ring | 9. Focus-adjustment Ring |
| 4. Zoom Knob | 10. Objective Lens |
| 5. Menu Button | 11. Battery Compartment |
| 6. Record Button | 12. Battery Cap |







On-Screen Display



| | |
|----------------------------|------------------------------|
| 1. Recording Indicator* | 10. Storage Error Indicator* |
| 2. PiP Window | 11. Wi-Fi Indicator* |
| 3. PiP Reticle | 12. Compass Indicator* |
| 4. Current Color Mode | 13. Microphone Indicator* |
| 5. Screen Brightness Level | 14. DNT Logo |
| 6. Current Time | 15. Compass |
| 7. Battery Level* | 16. Reticle |
| 8. Current Magnification | 17. Tilt Angle Indicator |
| 9. Roll Angle Indicator | |

Recording Indicator: Indicates the recording status. The timer shows the current video recording duration.

Battery Level: Indicates the current battery level. See the table below for details.

| Icon | Status | Battery Status |
|---|-------------|---------------------|
|  | Low Battery | 0% ~ 10% |
|  | 1 bar | 10% ~ 20% |
|  | 2 bars | 20% ~ 50% |
|  | 3 bars | 50% ~ 80% |
|  | 4 bars | 80% ~ 100% |
|  | USB Powered | Connected to Type-C |

Storage Error Indicator: Indicates when an internal storage error has occurred.

Wi-Fi Indicator: Indicates Wi-Fi is ON. No display when Wi-Fi is OFF.

Compass Indicator: Indicates that the compass is ON.

Microphone Indicator: Indicates whether the recorded video has sound. (A mute icon  is displayed when the microphone is OFF.)

Specifications

| Sensor Specifications | |
|--|--------------------------------------|
| Sensor Resolution | 1920 × 1080 pixels |
| Sensor Frame Rate | 50 fps |
| Recording Format | 1920 × 1080 pixels @ 50 fps |
| Optical Specifications | |
| Digital Magnification | 1–6x |
| Field of View Horizontal/Vertical/Diagonal | 27.0° / 15.4° / 30.8° |
| Eye Relief | 65 mm / 2.6 in |
| Diopter Adjustment | ±2 D |
| Detection Range | 400 m / 437 yd |
| Display Specifications | |
| Display Type | Micro-OLED |
| Display Resolution | 1920 × 1080 pixels |
| Display Refresh Rate | 50 Hz |
| Battery & Power Supply | |
| Battery Type | 18650 Battery (Flat-top) |
| Operating Time | 6 h |
| External Power Supply | 5 V USB-C |
| Physical Specifications | |
| Net Weight | 390 g / 13.76 oz |
| Total Weight (incl. Battery & QDS-150) | Approx. 587 g / 20.71 oz |
| Dimensions | 99 × 73 × 63 mm / 3.9 × 2.9 × 2.5 in |
| Built-in Memory | 32 GB eMMC (TLC) |
| Ingress Protection Rating | IP67 |
| Recoil Rating | 800 Gs / .50 BMG |
| Connections / App | Wi-Fi / DNT App |

Download the DNT App

Scan the QR codes below to download the DNT App and connect your device to your smartphone.

By connecting your NVMD to your smartphone, you can view the scope's live feed, manage, edit, and share recordings.



Android 9.0 and above



iOS 12.0 and above

START USING

This part covers everything you need to know to get your NVMD ready to use for the first time.

Installing Battery

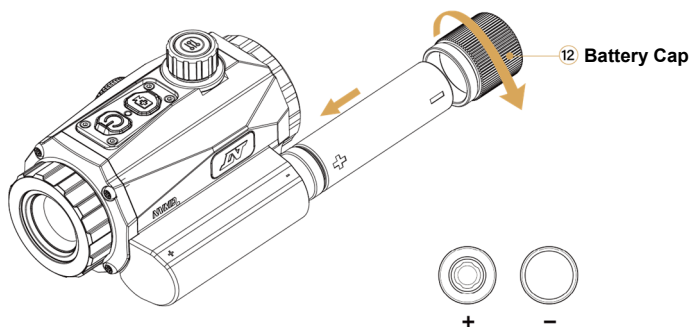



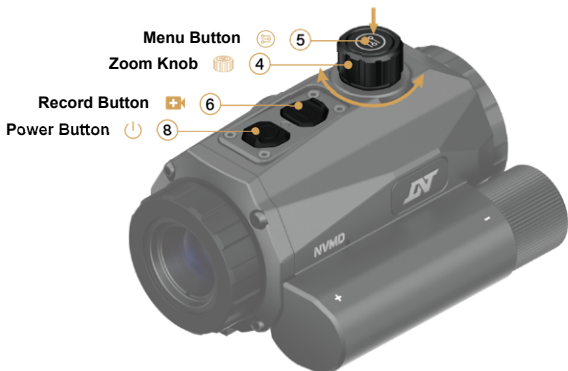

1. Twist the **Battery Cap** counterclockwise to remove it.
2. Insert the 18650 battery into the **Battery Compartment**, with the positive (+) end facing inward.
3. Press the **Battery Cap** against the battery's negative (-) end and twist it clockwise until fully tightened.

Quick Start

In Live View



| | |
|---|--|
| Power Button  | PRESS → Toggle Standby Mode ON/OFF |
| | LONG-PRESS → Turn NVMD ON/OFF |
| Menu Button  | PRESS → Cycle through Five Display Brightness Levels |
| | LONG-PRESS → Enter [Main Menu] |
| Record Button  | PRESS → Start/End Recording |
| | LONG-PRESS → Cycle through Four Color Modes |
| Zoom Knob  | ROTATE → Zoom IN (clockwise) Zoom OUT (counterclockwise) |

Menu Navigation

In Live View

Long-press **Menu Button** to enter [Main Menu].

In Menu (including the main menu and all sub-menus)

Rotate **Zoom Knob** clockwise to navigate DOWN.

Rotate **Zoom Knob** counterclockwise to navigate UP.

*Selected menu items will turn **YELLOW**; their names will be presented at the top of the menu list.*

Press **Menu Button** to navigate FORWARD.

This will either confirm the current selection to bring up the next menu pane, toggle functions ON/OFF, or lock in on a menu item for value changes.

Long-press **Menu Button** to navigate BACKWARD.

This will return to the previous menu pane, and, while in Main Menu, return to Live View.

When Changing Values (e.g., Changing Reticle Position)

Rotate **Zoom Knob** clockwise to INCREASE the value.

Rotate **Zoom Knob** counterclockwise to DECREASE the value.

In certain sub-menus like [Date/Time], where items are aligned horizontally, rotating the Zoom Knob will navigate LEFT and RIGHT.

Diopter and Focus Adjustments

Diopter Adjustment

This adjustment helps achieve the best screen clarity for your eye and is independent of the target (therefore, you can set it even with the objective lens cap closed).

Look through the **Ocular Lens** from about 65 mm / 2.6 in away. You should see the entire screen.

Slowly rotate **Diopter-adjustment Ring** clockwise or counterclockwise until you achieve the best screen clarity. Once set, no further adjustment is needed.



Focus Adjustment

You may need to adjust the focus to achieve optimal clarity when viewing targets at different ranges.

Make sure your diopter is adjusted, and you have perfect vision of the screen.

If the screen can't display the target clearly, slowly rotate **Focus-adjustment Ring** clockwise or counterclockwise until the screen displays the target perfectly clear.

Zeroing NVMD

■ Zeroing Menu



To Enter the Zeroing Menu:

[Main Menu] > [Zeroing]

Rotate **Zoom Knob** to navigate UP or DOWN, and press **Menu Button** to lock in on an item and start adjusting the value.

Rotating **Zoom Knob** clockwise will INCREASE the value, counter-clockwise will DECREASE the value.

- ① Select [Zeroing Profile] to switch between 10 onboard profiles.
- ② In Zeroing Menu, press **Power Button** to freeze/unfreeze the current image or select [Freeze] and toggle with **Menu Button**.
- ③ Select [X] to adjust the horizontal positions of the reticle.
- ④ Select [Y] to adjust the vertical positions of the reticle.
- ⑤ Select [Save] to save and exit.
- ⑥ Select [Exit] to exit without saving.

■ Zeroing in Scope Mode

1. Make sure the NVMD is tightly mounted and held steady.
2. Enter the Zeroing Menu:

[Main Menu] > [Zeroing]



Figure 1



Figure 2

3. Find/Place a target at your desired zero distance (DNT recommends 50 yards/meters). Adjust focus and zoom to get a clear sight.
4. Use the center of the reticle as the Point of Aim (POA) and acquire your Point of Impact (POI) (illustrated as + on **Figure 1**).
5. Move the center of the reticle back to the POA, then freeze the image.
6. In [X] and [Y], adjust the position of the reticle so that its center matches the POI +, as shown in **Figure 2**.
7. Select [Save] and confirm to save and exit. Your new POA is now zeroed with the POI at your selected distance.

■ Zeroing in Clip-On Mode

1. Make sure the NVMD is tightly mounted and that your glass optic is already zeroed. Adjust parallax on your glass optic until you get a clear view of the NVMD screen.
2. Enter the [Clip-On Zeroing]:

[Main Menu] > [Clip-On Zeroing]

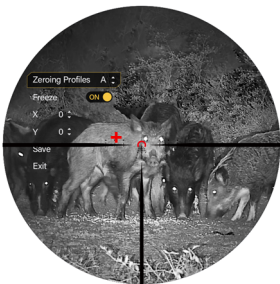

Figure 3

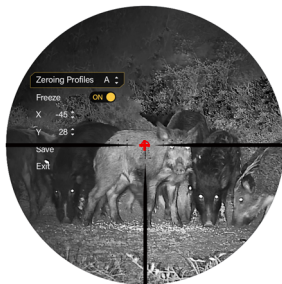

Figure 4

3. Find/Place a target at your desired zero distance (DNT recommends 50 yards/meters). Adjust focus on NVMD until the target appears in clear view.
4. Use the center of the reticle in your glass optic as POA and acquire your POI (illustrated as + on **Figure 3**).
5. Move your glass optic reticle back to the POA, then freeze the image.
6. In [Clip-On Zeroing], use [X] and [Y] to adjust the position of NVMD's screen display so that the POI + on the screen matches the center of your glass optic's reticle, as shown in **Figure 4**.
7. Select [Save] and confirm to save and exit. Your new POA is now zeroed with the POI at your selected distance.

FUNCTIONS

This chapter will explain in detail the main features and functions that NVMD includes, to help you master the operation of your device.

Power

■ Powering On/Off NVMD

Long-press **Power Button** to power ON/OFF the device.

***Note:** The power status of this device is indicated by the Power Indicator:*

*When the device is powered on and operating, the Power Indicator will shine **BLUE**.*

*When the device is in Standby Mode, the Power Indicator will shine **ORANGE**.*

*When performing an OTA firmware update, the Power Indicator will flash **ORANGE**.*

■ Standby Mode

When NVMD is powered ON and not in Menu, press **Power Button** to toggle Standby Mode ON/OFF.

***Note:** To maximize battery life during your session, enable Standby Mode whenever the device is idle. Resuming from Standby within 30 seconds will be instant. If NVMD has been in Standby for more than 30 seconds, resuming will take about 2 seconds. (The Standby logic in Flip-to-side Mode is different. Please see Page 23 - Flip-initiated Standby.)*

If NVMD is recording, enabling Standby Mode will stop and save the current recording. Once you turn Standby Mode OFF, NVMD will automatically start recording a new clip. This is ideal for users who want to capture all active moments throughout their sessions.

■ Auto Power-Off

NVMD comes with an Auto Power-Off function, which will automatically turn off the device after it enters Standby Mode for a set duration (10, 20, or 30 minutes). By default, this function is not enabled. You can set it up through:

[Main Menu] > [Function Settings] > [Auto Power Off]

Note: DNT recommends enabling Auto Power-Off to maximize battery efficiency and avoid unwanted battery drain.

Display

■ Adjusting Screen Brightness

In Live View, press **Menu Button** to cycle through five Brightness levels.

■ Zooming In/Out

In Live View, rotate **Zoom Knob** clockwise to zoom IN, and counter-clockwise to zoom OUT. NVMD has three sight modes and three magnification profiles. By default, they correspond as follows:

| | |
|-----------------------|--|
| Scope Mode | Default: 1x/2x/3x/4x/5x/6x; users can switch among magnification profiles. |
| Clip-On Mode | Fixed: 1x; switching magnification profiles won't change the zoom level. |
| Magnifier Mode | Default: 1x/3x; users can switch among magnification profiles. |

In [Scope Mode] and [Magnifier Mode], you can switch magnification profiles through:

[Main Menu] > [Magnification Settings]

You can choose from [1-6x] (1x/2x/3x/4x/5x/6x), [1x/3x] and [1x/5x].

■ Switching Image Modes

In Live View, long-press **Record Button** to cycle through four image modes. See the images below for their names and effects:



Full-Color



Black&White



White Phosphor



Green Phosphor

***Note:** All four image modes provide the same night vision capability, including Full-Color Mode. You may need to switch among modes occasionally to improve target acquisition. The Full-Color Mode has reduced color reproduction in dark environments.*

For the best night vision performance, use the NVMD with an infrared flashlight.

■ Picture in Picture (PiP)

[Main Menu] > [PiP Settings]

In PiP mode, the small window size defaults to 10% of the large window.

For PiP window position, you can choose from [Left] / [Center] / [Right].

To disable the PiP window, select [Off].

Recording

■ Recording Start/End

In Live View, press **Record Button** to start recording. During recording, press **Record Button** to end the current recording. The recorded video will be saved in NVMD's internal storage.

Note: Each video will last for a maximum of 10 minutes. Once the time limit is reached, the recording will stop automatically.

Please closely monitor the available storage in your NVMD through

[Main Menu] > [System Settings] > [Available Storage]

Newly recorded videos will be saved even if storage is full. If the storage is full when new recordings are finished, recordings will be automatically deleted to free up space, from the oldest to the newest.

■ Loop Recording

To record your entire session, turn on Loop Recording through:

[Main Menu] > [Function Settings] > [Loop Recording]

In [Loop Recording], you can choose from [1 minute], [3 minutes], [5 minutes], or [Off].

Selecting any of these durations enables loop recording. When you press **Record Button** to start recording, the device will continuously record in fixed-length segments. Once the selected duration is reached, the recording automatically stops, saves the clip, and immediately starts a new one. This cycle continues until you press **Record Button** to stop.

■ Recoil Activated Video (RAV)

This feature automatically starts recording when significant recoil is detected. You can toggle this function through:

[Main Menu] > [Recoil Activated Video]

When RAV is ON and the recoil force reaches 450 Gs, the device automatically saves a video that includes 10 seconds before and after the shot. For optimal performance, we recommend using the RAV function with recoil stronger than .22LR.

Note: Unlike most other DNT digital scope products, NVMD does not support RAV Manual Mode. We recommend using the Flip-to-Side Action camera instead, which is exclusive to NVMD.

■ Audio Recording

To record audio along with your video, enable this setting. It is enabled by default and can be toggled through:

[Menu] > [Function Settings] > [Audio Recording]

Sight Modes

■ Scope Mode

To enable Scope Mode, navigate to:

[Main Menu] > [Sight Modes] > [Scope Mode]

In Scope Mode, NVMD is intended to be used as a standalone digital day/night scope. The reticle is displayed in Live View and can be calibrated in [Zeroing].

In Scope Mode, the default magnification profile ranges from 1x to 6x and can be switched to [1-3x] or [1-5x] through:

[Main Menu] > [Magnification Settings]

Note: The Flip-to-Side Action Camera function is not available in Scope Mode.

■ Clip-On Mode

To enable Clip-On Mode, navigate to:

[Main Menu] > [Sight Modes] > [Clip-On Mode]

In Clip-On Mode, NVMD is intended to be used as a digital/night vision clip-on for your Low Powered Variable Optics (LPVOs). This mode hides the reticle and shrinks the device UI to accommodate LPVO's field of view (FOV). In Clip-on Mode, [Reticle Zeroing] will be replaced by [Clip-On Zeroing], allowing you to adjust the position of the Live View.

Note: In Clip-On Mode, the device magnification is fixed at 1x. (Please see Page 15 for guidance of Clip-On Zeroing.) In Clip-On Mode, [Zeroing] becomes [Clip-On Zeroing]. Unlike adjusting the position of the digital reticle when zeroing in Scope Mode, zeroing NVMD in Clip-On Mode adjusts the position of NVMD's display so that the Point of Impact (POI) shown on NVMD's screen matches the Point of Aim (POA) of your zeroed glass optic.

The PiP and reticle-related functions are not available in Clip-On Mode.

■ Magnifier Mode

To enable Magnifier Mode, navigate to:

[Main Menu] > [Sight Modes] > [Magnifier Mode]

In Magnifier Mode, NVMD is intended to be used as a magnifier for your red dot sights. This mode hides the reticle and disables the [Reticle Zeroing] and [Reticle Settings] functions.

Note: In Magnifier Mode, the default magnification profile is [1x / 3x], which can be switched through:

[Main Menu] > [Magnification Settings]

■ Flip-to-side Action Camera (Only with QDF-170)

This feature is intended for those who want to use NVMD as a clip-on or magnifier. In collaboration with our QDF-170 quick-detach flip mount and a status sensor at the bottom of NVMD (see **Figure 5**), DNT has introduced a set of flip-initiated features to NVMD.

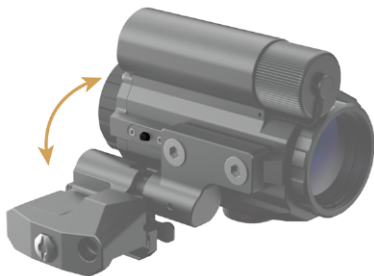

Figure 5

In Magnifier Mode and Clip-On Mode, you can enable the feature by:

[Main Menu] > [Flip-to-side Action Camera] > [ON]

When Flip-to-side Action Camera is ON

NVMD automatically starts recording when flipped from upright to the side. This action creates a portrait, UI-free, first-person-view video clip at 1080 × 1920 resolution.

When Flip-to-side Action Camera is OFF

NVMD automatically enters Standby Mode when flipped, enhancing the tactical experience while conserving battery life.

■ Flip-initiated Standby (Only with QDF-170)

When flipped, the device first enters a Shallow Standby state:

Shallow Standby (0-10 minutes)

Only the display is turned off, allowing for instant wake-up as soon as the device is flipped back.

Deep Standby (after 10 minutes of stillness)

The device fully enters Standby Mode, requiring about 2 seconds to wake.

Wake-up Behavior

If Standby is activated by flipping, the device can be woken either by flipping it back or by pressing **Power Button**.

If Standby is activated via **Power Button**, it can only be woken using the **Power Button**.

Peripherals

■ Gyroscope Function & Calibration

The NVMD includes a built-in gyroscope that measures the tilt and roll angle of the device. Over time, the gyroscope may lose accuracy and require calibration.

To calibrate the gyroscope, navigate to:

[Main Menu] → [Function Settings] → [Gyroscope] → [Calibration]

1. The display will show the prompt:
“Keep the Device Leveled During Gyroscope Calibration”, followed by an 8-second countdown.
2. Place the device on a stable, leveled surface. You may use an external level for best results.
3. Wait until the calibration completes automatically.



① Gyroscope: Tilt



② Compass



③ Gyroscope: Roll



■ Compass Function & Calibration

Apart from the gyroscope, the NVMD also includes a built-in electronic compass. When enabled, the compass reading is displayed in the lower-left corner of the screen.

Reliability Notice

Electronic compasses (e-compasses) are inherently sensitive to surrounding magnetic fields and metallic objects. For this reason, DNT has set the NVMD compass function to be disabled by default. If you choose to enable it, please use the compass reading for reference only. Accuracy may vary depending on your environment.

Compass Display Colors



White

Normal operation

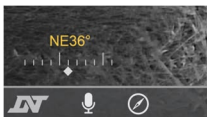

Yellow

Magnetic interference
detected



Red

Calibration required

*Note: Move the
device away from
sources of
interference*

Compass Calibration

Make sure the gyroscope is calibrated before calibrating compass. (See Page 24 for gyroscope calibration)

When the compass reading stays red, it indicates that the compass needs calibration. Follow the steps below to perform calibration:

Although NVMD can be calibrated when mounted, DNT recommends detaching it and holding it in your hand for the easiest operation.

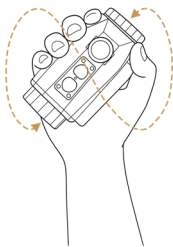
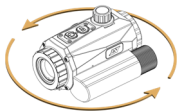
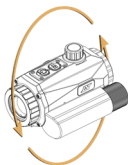

Figure 6

1. As **Figure 6** shows, hold the NVMD firmly in your hand and gently rotate your wrist in a figure “8” motion.
2. Make sure NVMD senses movements along all three axes: Pan, Tilt and Roll. After 8 seconds, check whether the display shows a white reading.
3. If the reading stays red despite the figure “8” movement, please refer to the following graphs to perform movements on all three axes accordingly:



Pan



Tilt

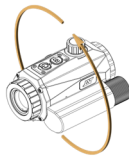

Roll

Connections

■ Connecting to the DNT App

1. Turning on the device Wi-Fi:

[Main Menu] > [Connections] > [Wi-Fi] > [On]

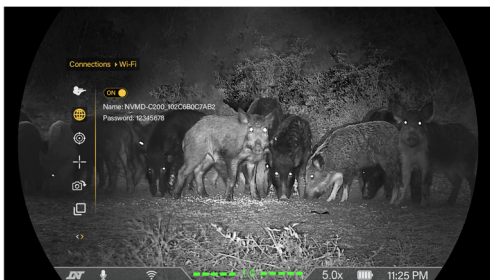

2. In your phone's Settings, turn on Wi-Fi, find the device's Wi-Fi name, and enter the corresponding password (normally 12345678) to connect your phone to the device Wi-Fi.

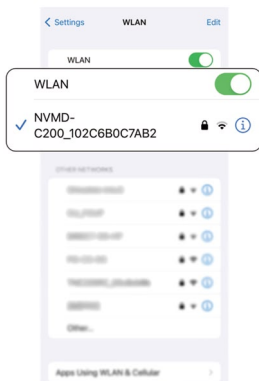

3. Open the DNT App, tap [Add Device], select [NVMD Multi-purpose], find [NVMD-C200], and tap it to add. This will take you to WLAN settings.

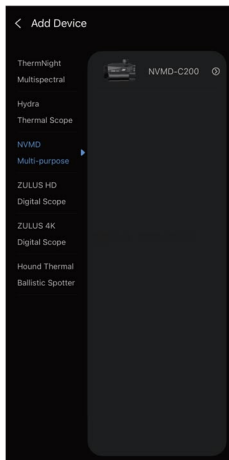

■ Managing Recorded Videos via the DNT App

In the DNT App, under the [Album] tab, there are three sections: [Device Files], [Local Files], and [Edit Files].

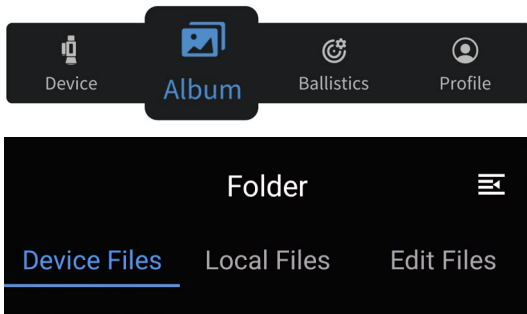

Device Files





This is where all recorded videos are stored. You can only access these files when the device is connected to your phone via Wi-Fi.

Local Files

This is where videos saved from the device are stored within the app. Tap a video to preview it, then use the four buttons in the upper right corner to **edit** (Merge, Trim, Slow), **save** it to your phone/tablet's album, **share** it on social media, or **delete** it.

Edit Files

This section displays videos that have been edited using the Merge, Trim, or Slow functions. You can perform the same actions as in Local Files: **edit** again, **save** to album, **share**, or **delete**.

| Button Icon | Button Name | Function Description |
|---|----------------------------|---|
|  | Edit | Edit the video (Merge, Trim, Slow). |
|  | Save to Album | Save the video to your phone or tablet's album. |
|  | Share | Share the video on social media platforms. |
|  | Delete | Delete the video. |
|  | Save to Local Files | Save the video from Device Files to Local Files in the app. |

To Save Videos to Local Files

In the [Device Files] and [Edit Files] tabs, select the video you want, and tap the **Save to Local Files button** in the upper right corner to save it to [Local Files]. Once saved, you can access the video within the app even when the device is disconnected.

To Save Videos to Your Phone/Tablet's Album

First, save the video from [Device Files] to [Local Files]. Then, go to [Local Files], open the video you want, and tap the **Save to Album button** in the upper right corner to save it to your phone or tablet's album. You can also save edited videos by following the same steps from the [Edit Files] section.

■ USB-C Connection

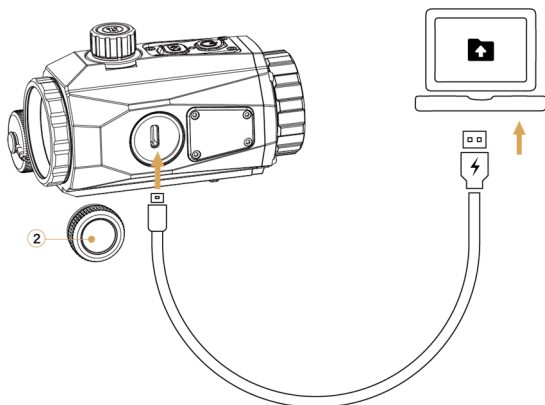





Connecting NVMD with your PC/Mac via a USB-C data cable.

NVMD will appear on your computer as a USB drive where you can manage your recordings.

APPENDIX









Table of Controls



| Control | Status | Press | Long-press |
|---|--------------------------|--|--------------------------------|
| Power Button  | Power Off | -- | Turn NVMD ON |
| | Live View | Enter Standby Mode | Turn NVMD OFF |
| | Standby Mode | Exit Standby Mode | -- |
| Record Button  | Live View | Start/End Recording | Cycle through Four Sight Modes |
| | Zeroing Screen | Cycle through Magnification Levels | -- |
| Menu Button  | Live View | Cycle through Screen Brightness Levels | Enter Main Menu |
| | Menu | Confirm Selection | Return to Previous Menu |
| | Date/Time Setting | Confirm Selection | Save and Exit |

| Control / Status | Live View | Menu | Date / Time Setting |
|--|----------------------|---------------------|------------------------|
| Rotate Zoom Knob  | Adjust Magnification | Move Cursor Up/Down | Move Cursor Left/Right |

Understanding this table: Performing a specific action (press, long-press, or rotate) on a specific [Control] (button or knob) under a [Status] will execute the corresponding operation on the device.

Table of Menus

| Icon | Description |
|---|--|
|  | Sight Modes [Scope Mode] / [Clip-On Mode] / [Magnifier Mode] |
|  | Connection Turn Wi-Fi [ON] / [OFF] |
|  | Zeroing Open Zeroing View |
|  | Reticle Settings Reticle styles: [BRR BDC] / [POST] / [ROUND CROSS HIDE] Reticle colors: [Red] / [Green] / [Yellow] / [Black] / [White] |
|  | Flip to Side Action Camera Toggle [ON] / [OFF] |
|  | PiP Settings [Off] / [Left] / [Center] / [Right] |
|  | Recoil Activated Video Toggle [ON] / [OFF] |
|  | Magnification Settings [1-6x]: 1x / 2x / 3x / 4x / 5x / 6x [1x/3x]: 1x / 3x [1x/5x]: 1x / 5x |
|  | Mode Switch [Full Color] / [Black & White] / [Green Phosphor] / [White Phosphor] |

| Icon | Description |
|---|--|
|  | <p>Function Settings</p> <p>Auto Power Off: [Off] / [10 minutes] / [20 minutes] / [30 minutes] Loop Recording: [Off] / [1 minute] / [3 minutes] / [5 minutes] Audio ON/OFF: [ON] / [OFF] Gyroscope: [ON] / [OFF] / [Calibration] Compass: [ON] / [OFF] Screen Brightness: [LEVEL 1] / [LEVEL 2] / [LEVEL 3] / [LEVEL 4] / [LEVEL 5]</p> |
|  | <p>System Settings</p> <p>Date/Time: Set the device's date and time Language: Select system language: [English] / [Français] / [Español] / [Deutsch] / [Italiano] Format: Erase all files from the memory card Restore Default Settings: Reset the device to factory defaults Available Storage: View current available memory space Version No.: Display the current firmware version</p> |

FCC WARNING

This device complies with Part 15 of the FCC Rules. Operation is subject to the following two conditions: (1) this device may not cause harmful interference, and (2) this device must accept any interference received, including interference that may cause undesired operation.

Any changes or modifications not expressly approved by the party responsible for compliance could void the user's authority to operate the equipment.

NOTE: This equipment has been tested and found to comply with the limits for a Class B digital device, pursuant to Part 15 of the FCC Rules. These limits are designed to provide reasonable protection against harmful interference in a residential installation. This equipment generates, uses and can radiate radio frequency energy and, if not installed and used in accordance with the instructions, may cause harmful interference to radio communications. However, there is no guarantee that interference will not occur in a particular installation.

If this equipment does cause harmful interference to radio or television reception, which can be determined by turning the equipment off and on, the user is encouraged to try to correct the interference by one or more of the following measures:

- Reorient or relocate the receiving antenna.
- Increase the separation between the equipment and receiver.
- Connect the equipment into an outlet on a circuit different from that to which the receiver is connected.
- Consult the dealer or an experienced radio/TV technician for help.

To maintain compliance with FCC's RF Exposure guidelines, this equipment must be installed and operated with a minimum distance of 20cm between the radiator and your body. Use only the supplied antenna.





< Scan to check for the latest available version online. >

www.dntoptics.com