

User Manual

Multi-Spectrum Binocular

HABROK Pro SERIES

V5.5.136 202511



Contact Us

CONTENTS

1	Overview	1
1.1	Main Function.....	1
1.2	Appearance.....	2
2	Preparation	5
2.1	Install Battery.....	5
2.1.1	Battery Instruction	5
2.1.2	Battery Installation.....	5
2.2	Remove Battery	6
2.3	Charge Device.....	6
2.3.1	Charge Device via Type-C Interface.....	6
2.3.2	Charge Battery via Battery Charger	7
2.4	Change Illuminator (Optional)	8
2.5	Attach Neck Strap	9
2.6	Attach Straps of Carrying Bag	11
2.7	Attach Tripod Adapter.....	11
2.8	Power On/Off.....	12
2.9	Auto Screen Off	13
2.10	Menu Description	14
2.11	App Connection.....	15
2.12	Firmware Status	16
2.12.1	Check Firmware Status.....	16
2.12.2	Upgrade Device	16
3	Image Settings	18
3.1	Adjust Device.....	18
3.2	Adjust Brightness	19
3.3	Adjust Contrast.....	19
3.4	Adjust Tone.....	19
3.5	Adjust Sharpness	20
3.6	Select Scene	21
3.7	Set Palettes.....	21
3.8	Set Display Mode.....	24
3.9	Set Image Style.....	26
3.10	Set Picture in Picture Mode	27
3.11	Adjust Digital Zoom.....	28
3.12	Flat Field Correction.....	28
3.13	Correct Defective Pixel.....	28
3.14	Set Infrared Light.....	29
3.15	WDR.....	30
3.16	Zoom Pro	30

Multi-Spectrum Binocular User Manual

4	Measure Distance	32
5	Ballistic Calculation for Hunting	34
6	General Settings	36
6.1	Set OSD	36
6.2	Set Brand Logo	36
6.3	Burning Prevention	36
6.4	Capture and Video.....	37
6.4.1	Capture Picture	37
6.4.2	Set Audio	37
6.4.3	Record Video.....	37
6.4.4	View Local Album	38
6.5	Hot Tracking	39
6.6	Export Files	40
6.6.1	Export Files via HIKMICRO Sight.....	40
6.6.2	Export Files via PC	41
6.7	Direction Display.....	41
6.7.1	Switch on Compass.....	41
6.7.2	Calibrate Compass	42
6.7.3	Magnetic Declination Correction	43
6.8	Geographic Location Display.....	44
7	System Settings	46
7.1	Adjust Date	46
7.2	Synchronize Time.....	46
7.3	Set Language.....	46
7.4	Cast Device Screen to PC	47
7.5	Set Unit.....	47
7.6	Save Diagnostic Log.....	47
7.7	Set Screen Lock Passcode	48
7.7.1	Enable Passcode	48
7.7.2	Change Passcode.....	49
7.8	View Device Information.....	49
7.9	Format.....	49
7.10	Restore Device.....	50
7.11	Reset Device	50
8	Frequently Asked Questions	51
8.1	Why does the charge indicator flash improperly?	51
8.2	Why is the power indicator off?	51
8.3	The image is not clear, how to adjust it?	51
8.4	Capturing or recording fails. What's the problem?.....	51
8.5	Why the PC cannot identify the device?.....	51

1 Overview

HIKMICRO HABROK Pro series is a powerful and innovative multi-spectrum binocular. This all-in-one binocular can be mainly applied in forest & field hunting, birding, animal searching, adventuring, and rescuing in various weather conditions.

- High thermal sensitivity ensures detail recognition even when there is minimal temperature difference between the object and background.
- Advanced 4K digital detector with 60 mm lens for excellent detail recognition capability in true living color.
- Replaceable IR illuminator brings superior clarity in classic black/white images in darkness.
- Precise built-in laser rangefinder capable of measuring distance up to 1,000 m.

1.1 Main Function

- **Smart IR:** The smart IR function helps to view targets clearly in dark environment.
- **Image Pro 3.0:** Featured with Image Pro 3.0 imaging algorithm, the device delivers minimal details of animals' characteristics and layered backgrounds with less noise.
- **Sync Pro (Available for Certain Models):** The Sync Pro imaging workflow enhancement algorithm shortens the imaging process and provides low-latency, synchronized thermal images.
- **WDR:** WDR (Wide Dynamic Range) enhances the viewing experience by providing better image quality in diverse lighting conditions.
- **Large Digital Zoom:** Digital zoom offers better focus on small target from a far distance.
- **Video and Audio Recording:** The built-in memory module supports video recording. Audio function allows you to record the sound during video recording.
- **Local Album:** Captured images and recorded videos are stored in the device, and you can view the files in the local albums.
- **Compass:** The device can detect the azimuth angle and elevation angle and show the direction information on the screen.
- **Distance Measurement:** Built-in laser range finder provides an accurate distance between the target and the observation position.

- **App Connection:** The device can capture snapshots, record videos, and set parameters by HIKMICRO Sight app after being connected to your phone via hotspot.

1.2 Appearance



Note

- The appearance may vary according to different models. Please take the actual product for reference.
- Pictures in this manual are for illustration purpose only. Please take the actual product for reference.

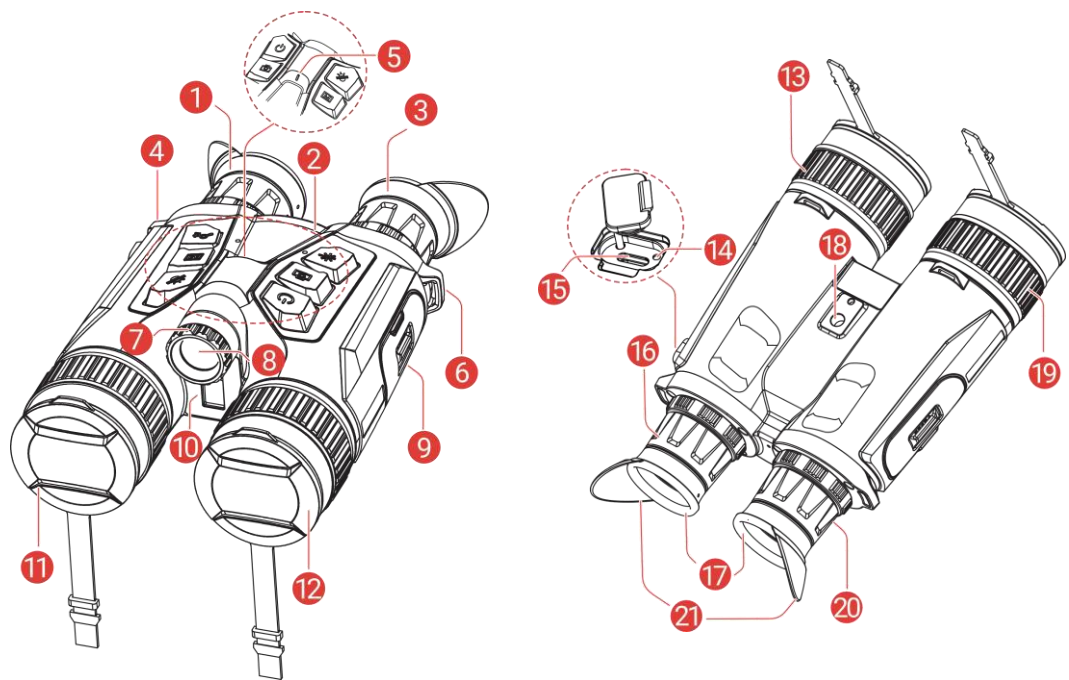

Figure 1-1 Appearance

Table 1-1 Description of Components



No.	Component	Description
1 & 3	Eyepiece	The piece placed closest to the eye to view the target. Adjust the interpupillary distance by moving the eyepieces farther or closer to each other.
2	Buttons	To set functions and parameters.
4 & 6	Neck Strap Attachment Point	Attaches the neck strap.
5	Power Indicator	Indicates the device status. It stays solid red when the device is on.

Multi-Spectrum Binocular User Manual





7	Beam Angle Adjustment Knob	Adjusts the beam angle of IR illuminator.
8	Removable IR Illuminator	Helps to view target clearly in the dark environment. The illuminator can be changed with a compatible illuminator for better viewing experience.
9	Battery Compartment	For holding the battery.
10	Laser Rangefinder	Measures the distance to the target with laser.
11	Thermal Lens	For thermal imaging.
12	Digital Lens	For digital imaging.
13 & 19	Focus Ring	Adjusts focus to obtain clear targets.
14	Charging Status Indicator	Indicates the charging status of the device. <ul style="list-style-type: none"> ● Flashing Red & Green: Error occurred. ● Solid Red: Charging. ● Solid Green: Fully charged.
15	Type-C Interface	To connect the device to power supply or transmit data with a type-C cable.
16 & 20	Diopter Adjustment Ring	Adjusts the dioptic setting.
18	Tripod Adapter Socket	Attaches the tripod adapter.
17 & 21	Eyecup	<ul style="list-style-type: none"> ● Unfoldable Eyecup Part (17): cannot be folded, forcefully folding may cause sudden elastic rebound, posing a risk of injury. ● Foldable Eyecup Part (21): can be folded if wearing glasses.

Button Description

Table 1-2 Button Description

Icon	Button	Function
	Power	<ul style="list-style-type: none"> ● Press: Standby mode/Wake up device. ● Hold: Power on/off.
	Capture	<ul style="list-style-type: none"> ● Press: Capture snapshots. ● Hold: Start/Stop recording videos.

Multi-Spectrum Binocular User Manual

	Measure	<ul style="list-style-type: none"> ● Press: Turn on laser ranging. ● Double Press: Turn off laser ranging. ● Hold: Correct non-uniformity of display (FFC).
	Mode	<p>Non-Menu Mode:</p> <ul style="list-style-type: none"> ● Press: Switch palettes. ● Hold: Switch display mode. <p>Menu Mode: Press to move up.</p>
	Menu	<p>Non-Menu Mode:</p> <ul style="list-style-type: none"> ● Press: Enter the menu. ● Hold: Switch image style. <p>Menu Mode:</p> <ul style="list-style-type: none"> ● Press: Confirm/Set parameters. ● Hold: Save and exit menu.
	Zoom	<p>Non-Menu Mode:</p> <ul style="list-style-type: none"> ● Press: Switch digital zoom. ● Hold: Turn on/off PIP (Picture-in-Picture). <p>Menu Mode: Press to move down.</p>



Note

When the auto screen off function is enabled, if you press  to enter standby mode, you can also tilt or rotate the device to wake up the device. Refer to *Auto Screen Off* for detailed operation.

2 Preparation

2.1 Install Battery

2.1.1 Battery Instruction

- Remove the battery if the device is not used for a long time.
- The device supports removable rechargeable li-ion battery, and the battery size should be 86 mm × 48 mm. The battery rated voltage and capacity is 7.2 V/4800 mAh.
- Charge the battery for more than 4 hours before first use.
- To ensure better conductivity, if the battery compartment cover gets dirty, use a clean cloth to wipe the thread.

2.1.2 Battery Installation

Insert the battery into the battery compartment.

Steps

1. Slide to unlock and open the battery compartment cover.

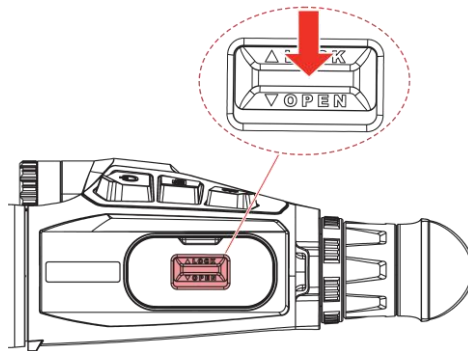

Figure 2-1 Open the Cover

2. Push the battery into the battery compartment. The latch locks the battery in place when the battery is fully inserted.

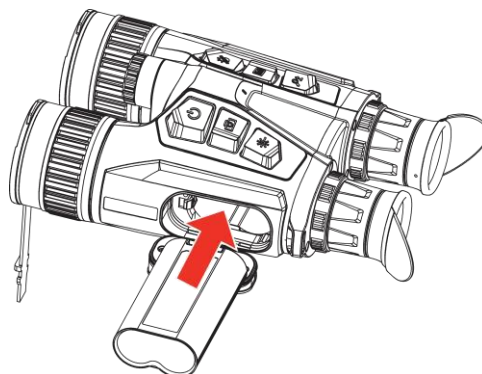

Figure 2-2 Install the Battery

3. Close the battery compartment cover and slide to lock it.

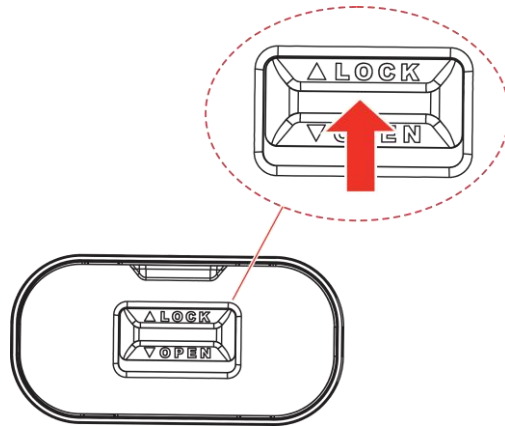

Figure 2-3 Close the Cover

2.2 Remove Battery

Steps

1. Turn off the device and open the battery compartment cover.
2. Push the battery latch (1) in the direction shown in figure to release the battery and then remove the battery.

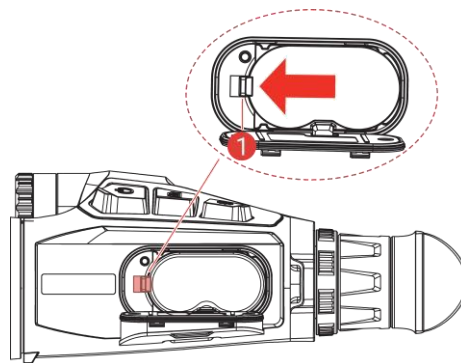

Figure 2-4 Remove Battery

2.3 Charge Device

2.3.1 Charge Device via Type-C Interface

Connect the device and power adapter with a type-C cable to charge the device. Alternatively, connect the device and PC to export files.

Steps

1. Lift the type-C interface cover.
2. Connect the device and power adapter with a USB-A to USB-C cable to charge the device.

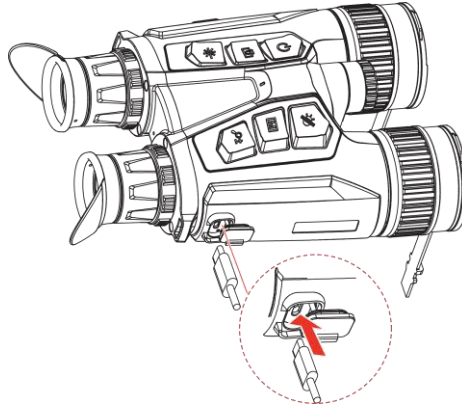

Figure 2-5 Charge Device



Note

- Please charge the device after the battery is installed in the battery compartment of the device.
 - Make sure the battery temperature is between 0 °C to 50 °C (32°F to 122 °F) when charging.
 - The device also supports fast charging. You need to purchase a PD USB-C power adapter and a USB type-C to type-C cable for fast charging.
-

2.3.2

Charge Battery via Battery Charger

Steps

1. Put one or two batteries in the charger.
2. Connect the charger and power adapter with a USB-A to USB-C cable to charge the batteries. The indicator in the middle is green if the charger works properly.
3. The left and right indicators show the charging status of the batteries.
 - Solid red: charging normally.
 - Solid green: fully charged.

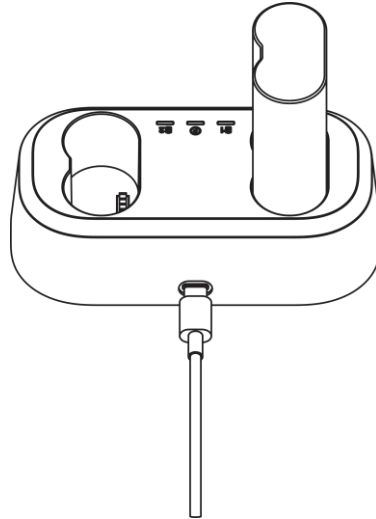

Figure 2-6 Charge Device via



Note

- Make sure the battery temperature is between 0 °C to 50 °C (32°F to 122 °F) when charging.
 - The battery charger also supports fast charging. You need to purchase a PD USB-C power adapter and a USB type-C to type-C cable for fast charging.
-

2.4

Change Illuminator (Optional)

The IR illuminator can be changed with another compatible illuminator for better viewing experience.

1. Rotate the IR illuminator counterclockwise to remove the IR illuminator.

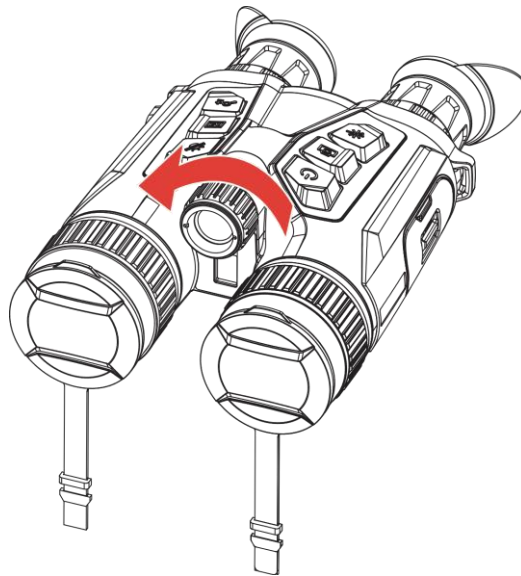

Figure 2-7 Remove the IR Illuminator

2. Align the replaceable illuminator with the interface on the device and insert it, then rotate the illuminator clockwise to secure the illuminator.

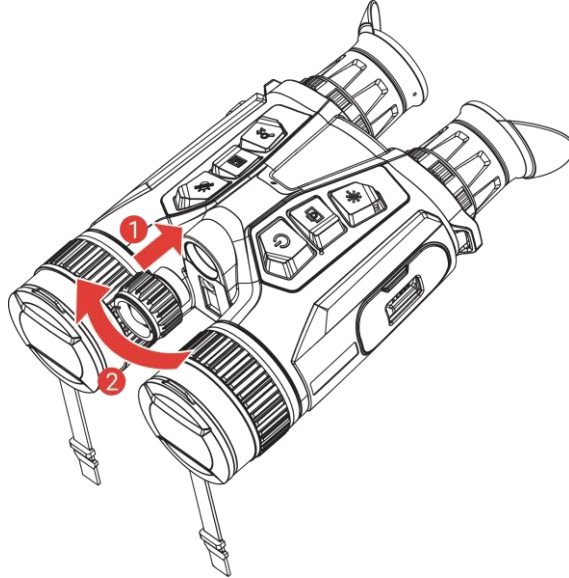

Figure 2-8 Mount the Illuminator



Note

- Please make sure the illuminator is vertically aligned with the interface on the device before screwing it in; otherwise, the installation may fail.
 - You can use the additional removable IR illuminator included in the package (available only for certain models) or purchase a compatible one separately.
-

2.5 Attach Neck Strap

Steps

1. Thread one end of the neck strap through a neck strap attachment point.

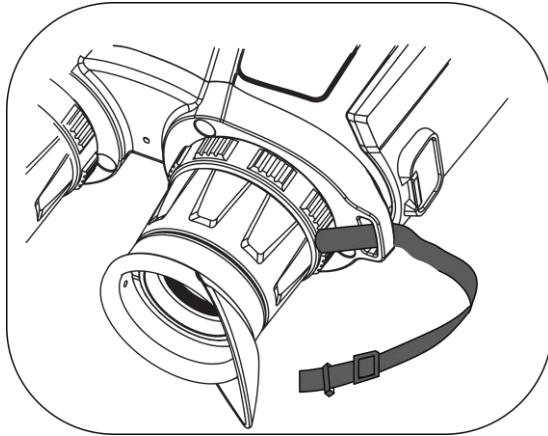

Figure 2-9 Thread Neck Strap through Attachment Point

2. Thread the neck strap through the strap buckle and fasten the neck strap, as shown in the picture.

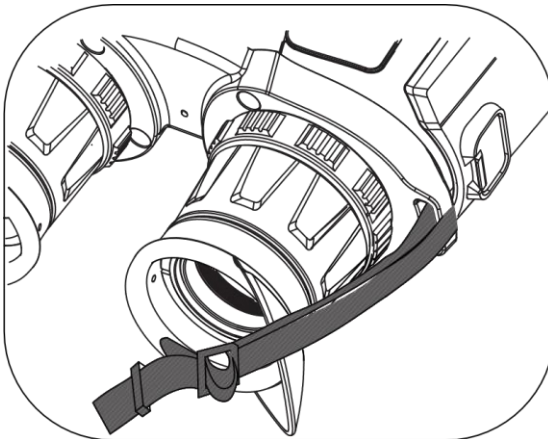

Figure 2-10 Thread Neck Strap through Strap Buckle

3. Thread the neck strap through the strap keeper.

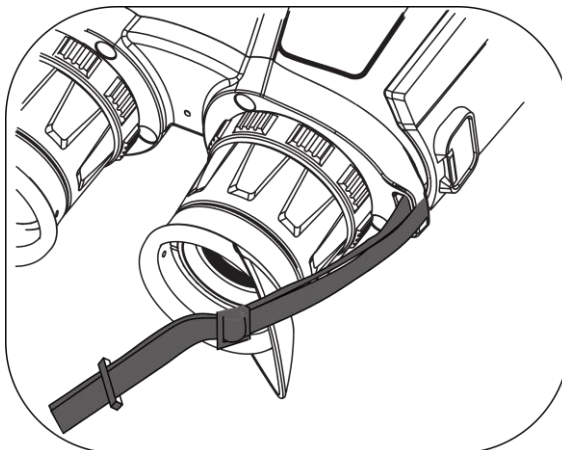

Figure 2-11 Thread Neck Strap through Strap Keeper

4. Repeat above steps to finish mounting, and adjust the length of neck strap as needed.

2.6 Attach Straps of Carrying Bag

The binocular carrying bag comes with 2 straps: a waist strap (1) and a four-point strap (2), which helps you with comfortable carrying on the chest and ensures the device safety. You can adjust the length of the straps according to your preference.



Figure 2-12 Binocular Carrying Bag

2.7 Attach Tripod Adapter

Steps

1. Align the tripod adapter with the socket on the device, and insert the location column (1) to the location point (2).

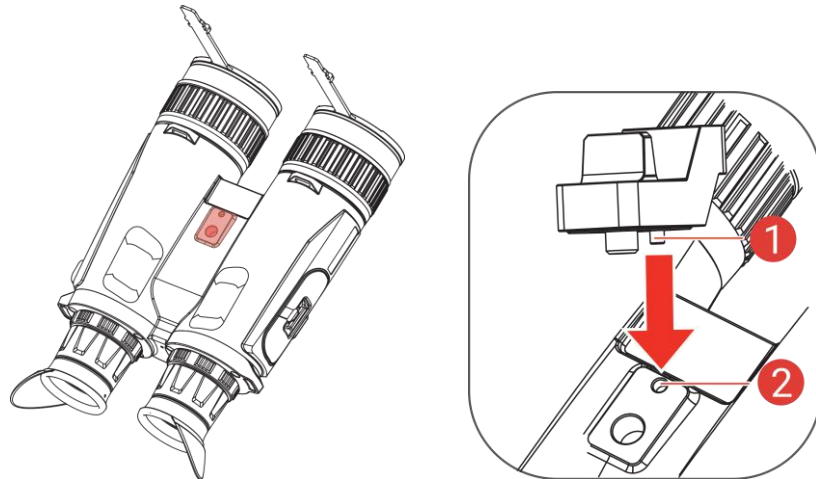

Figure 2-13 Insert the Column

2. Rotate the tripod adapter screw clockwise to fix the tripod adapter.

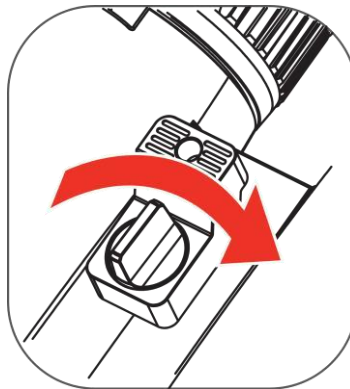



Figure 2-14 Rotate the Screw

2.8 Power On/Off

Power On

When the device is connected to cable or the battery is enough, hold  to power on the device.

Power Off

When the device is turned on, hold  to power off the device.













Note

- Power-off countdown will appear when you power off the device. You can press any key to interrupt the countdown and cancel the power-off.
 - Automatic low battery power-off cannot be canceled.
-

Auto Power Off



You can set the auto power off time for your device.

Steps

1. Press  to show the menu.
2. Go to  **Advanced Settings**, and press  or  to select .
3. Press  to enter the configuration interface.
4. Press  or  to select the auto power off time as required, and press  to confirm.
5. Hold  to save and exit.



Note







- See the battery icon for the battery status.  means the battery is fully charged,  means that the battery is low, and  means the battery charging is abnormal.
 - When the low power note shows, charge the battery.
 - The auto power off takes effect only when you don't operate the device and the device isn't connected with HIKMICRO Sight app at the same time.
 - The auto power off countdown will start again when the device reenters standby mode, or the device is restarted.
-

2.9

Auto Screen Off

Auto screen off function darkens the screen to save energy and increase battery time.

Steps

1. Enable auto screen off.
 - 1) Press  to show the menu.
 - 2) Go to  **Advanced Settings**, and press  or  to select .
 - 3) Press  to enable auto screen off.
 - 4) Hold  to save settings and exit.
2. Enter standby mode.

You can do one of the following methods to enter the standby mode when the display is turned on:

- Tilt the device downwards from 70° to 90°.
- Rotate the device horizontally from 75° to 90°.
- Keep the device still and do not move it for 5 minutes.

3. Wake up device.

You can do one of the following methods to wake up the device when the display is turned off:

- Tilt the device downwards from 0° to 60° or upwards from 0° to 90°.
- Rotate the device horizontally from 0° to 70°.
- Press  to wake up the device.



Note

After enabling the auto screen off, when you enter the menu, the auto screen off does not take effect until you exit the menu.

2.10 Menu Description

In the live view interface, press  to show the menu.

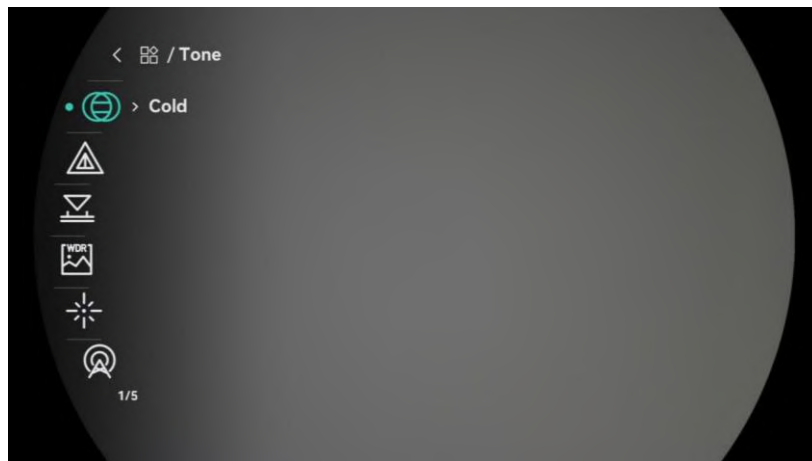





Figure 2-15 Menu Description

- Press  to move the cursor up.
- Press  to move the cursor down.
- Press  to confirm and hold it to exit the menu.

2.11 App Connection

Connect the device to the HIKMICRO Sight app via hotspot, then you can capture picture, record video, or configure parameters on your phone.

Before You Start

Confirm **Remote Access** is enabled on the device. Press  to enter the menu, and go to **Advanced Settings > Remote Access**.

Steps









1. Search the HIKMICRO Sight on App Store (iOS System) or Google Play™ (Android System) to download it, or scan the QR code to download and install the app.



Android System



iOS System

2. Press  to show the menu.
3. Go to  **Advanced Settings**, and press  or  to select .
4. Press  to enter the setting interface.
5. Press  or  to select **Hotspot_5G** or **Hotspot_2.4G**, and then the hotspot of 5 GHz or 2.4 GHz is enabled.
 - Use 2.4 GHz if your smartphone does not support 5 GHz.
 - 5 GHz is recommended for small-range scenarios within 5 m, such as mounting device on the vehicle. Otherwise, use 2.4 GHz.
6. Turn on the WLAN of your phone and connect to the hotspot.
 - Hotspot Name: HIKMICRO_Serial No.
 - Hotspot Password: Go to **Hotspot** in the menu to check the password.
7. Open the app, and confirm the connection PIN code on the device to connect your phone with the device. You can view the interface of device on your phone.



Note

- When the device is connected to your phone, you can change the hotspot password via the HIKMICRO Sight app.

- The hotspot password will be updated when you reset the device (refer to *Reset Device*). In this case, you need to reconnect to the device hotspot.
-

2.12 Firmware Status

2.12.1 Check Firmware Status

Steps

1. Open the HIKMICRO Sight and connect your device to the app.
2. Check if there is an upgrade prompt on the device management interface. If there is no upgrade prompt, the firmware is the latest version. Otherwise, the firmware is not the latest version.

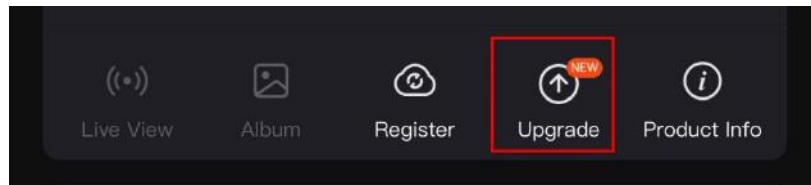

Figure 2-16 Check Firmware Status

3. (Optional) If the firmware is not the latest version, upgrade the device. See *Upgrade Device*.

2.12.2 Upgrade Device

Upgrade Device via HIKMICRO Sight

Steps

1. Open HIKMICRO Sight app and connect your device to the app.
2. Tap the upgrade prompt to enter the firmware upgrade interface.
3. Tap **Upgrade** to start upgrade.



Note









The upgrading operation may vary due to app updates. Please take the actual app version for reference.

Upgrade Device via PC

Before You Start

Please get the upgrade package first.

Steps

1. Press  to show the menu.
 2. Go to  **Advanced Settings**, and press  or  to select .
 3. Press  to enter the configuration interface.
 4. Press  or  to select **USB Flash Drive**.
 5. Connect the device to your PC with cable.
 6. Open the detected disk, copy the upgrade file and paste it to the root directory of the device.
 7. Disconnect the device from your PC.
 8. Reboot the device, and the device upgrades automatically. The upgrading process will be displayed in the main interface.
-



Caution

During the upgrade package transmission, make sure the device is connected to your PC. Otherwise, it may cause unnecessary upgrade failure, firmware damage, etc.

3 Image Settings

You can set palettes, brightness, scenes, FFC (flat field correction), and DPC (defective pixel correction) to display the better image effect.

3.1 Adjust Device

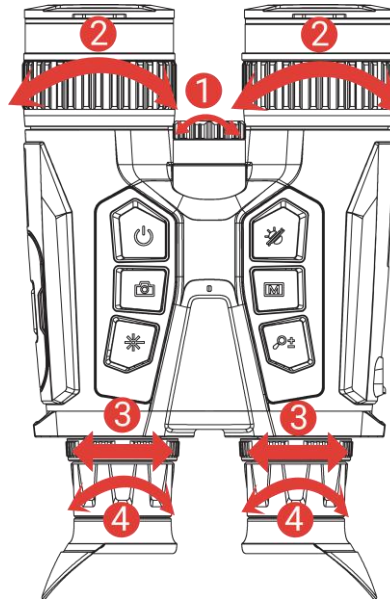

Figure 3-1 Adjust Device

① Adjust Beam Angle of IR Illuminator: Slightly rotate the adjustment knob to adjust the beam angle of the IR illuminator. The broader the beam angle is, the more spread-out but less intense the light will be.

② Adjust Focus: Slightly rotate the focus ring to adjust the focus of the objective lens.



Note

DO NOT touch the lens directly with your finger, or place any sharp objects near them.

③ Adjust Interpupillary Distance: Adjust the interpupillary distance by moving the eyepieces farther or closer to each other.

④ Adjust Diopter: Make sure the eyepiece covers your eye and aim at the target. Adjust the diopter adjustment ring until the OSD text or image is clear.



Note

When adjusting diopter, DO NOT touch the surface of lens to avoid smearing the lens.

3.2 Adjust Brightness

You can adjust the brightness in the menu.

Steps

1. Press to show the menu.
2. Press or to select and press to confirm.
3. Press or to adjust display brightness.
4. Hold to save settings and exit.

3.3 Adjust Contrast

Steps

1. Press to show the menu.
2. Press or to select and press to confirm.
3. Press or to adjust contrast.
4. Hold to save settings and exit.

3.4 Adjust Tone

Steps

1. Press to show the menu.
2. Go to **Advanced Settings**, and press or to select .
3. Press to confirm, and press or to select a tone. **Warm** and **Cold** can be selected.
4. Hold to save and exit.



Figure 3-2 Adjust Tone

3.5 Adjust Sharpness

Steps









1. Press  to show the menu.
2. Go to  **Advanced Settings**, and press  or  to select .
3. Press  to confirm, and press  or  to adjust sharpness.
4. Hold  to save and exit.













Figure 3-3 Sharpness Adjustment Comparison

3.6 Select Scene

You can select proper scene according to actual using scene to improve the display effect.









Steps

1. Press  to show the menu.
2. Go to  **Advanced Settings**, and press  or  to select .
3. Press  to enter the setting interface.
4. Press  or  to switch scene.
 - **Observation:** Observation mode is recommended in normal scene.
 - **Detection:** Detection mode is recommended in hunting environment.
5. Hold  to save settings and exit.

3.7 Set Palettes

You can select different palettes to display the same scene in different effects.

Steps

1. Press  to show the menu.
2. Go to  **Advanced Settings**, and press  or  to select .
3. Press  to go to the palettes interface.
4. Press  or  to select the palettes required, and press  to enable them.



Note

At least one palette should be enabled.

5. Hold  to save the settings and exit.

6. Press  in live view interface to switch the selected palettes.

Optical

The image of optical channel is displayed in this mode.



White Hot

The hot part is light-colored in view. The higher the temperature is, the lighter the color is.



Black Hot

The hot part is black-colored in view. The higher the temperature is, the darker the color is.



Red Hot

The hot part is red-colored in view. The higher the temperature is, the redder the color is.



Fusion

From high temperature to low temperature, the image is colored in from white, yellow, red, pink to purple.



Red Monochrome

The whole image is red colored. The higher the temperature is, the lighter the color is.





Green Monochrome

The whole image is green colored. The higher the temperature is, the lighter the color is.



3.8 Set Display Mode

You can select different display modes in different scenes. Hold  in live view interface to switch display modes in the optical channel. Day, night, green, yellow and auto modes are selectable.

- : Day Mode: You can use this mode at daytime and in bright environment. In day mode, the IR light is off automatically.



- 🌙 : Night Mode: You can use this mode at nights. In night mode, the IR light is on automatically.



- 🌿 : Green mode. It's a night vision mode. You can use this mode according to your personal preference.



- 🌟 : Yellow mode. It's a night vision mode. You can use this mode according to your personal preference.

















: Auto Mode: The day mode and night mode switch automatically according to the ambient brightness.

3.9 Set Image Style

You can set and select different image styles in different scenes for better viewing experience and image quality.

Steps

1. Press  to show the menu.
2. Press  or  to select .
3. Press  to enter the image style interface. Daylight, twilight, and night light are selectable. Press  or  to select the image style as required.
 -  Daylight: You can use this style at daytime and in bright environment.
 -  Twilight: You can use this style at twilight.
 -  Night Light: You can use this mode at night.
4. You can also set parameters for different styles according to your preference. Select one image style and press  to enter the setting interface.
5. Press  or  to select parameters, including brightness, contrast, tone, sharpness, and WDR. Then press  to set parameters as required.
6. Hold  to exit according to the prompt.
 - **OK:** Save all parameters and exit.

- **CANCEL**: Exit and not save the parameters.

7. Hold  in the live view interface to switch the image styles.



Note

- WDR takes effect only in optical mode. Sharpness and tone takes effect only in thermal mode.
 - If you set the parameters such as brightness, contrast, tone, sharpness, or WDR in the menu rather than in the image style settings, the device will prompt you to save the current style when you switch styles in the live view interface.
-

3.10 Set Picture in Picture Mode



Hold  in live view to enable PIP, and hold  again to exit PIP. The image center is displayed in upper middle of the interface.



Figure 3-4 Set PIP Mode



Note

- The PIP view temporarily displays the zoom ratio when adjusting the digital zoom of the device.
 - If the PIP function is enabled, only the PIP view zooms when adjusting the digital zoom ratio.
 - If the PIP function is enabled in thermal mode, the PIP view only switches between current palette and optical mode; if the PIP function is enabled in optical mode, the PIP view switches among the selected palettes and optical mode.
-

3.11 Adjust Digital Zoom

You can zoom in and out the image by using this function. Press  in the live view interface to switch the digital zoom.













Note

- When switching the digital zoom ratio, the left interface displays the actual magnification (Actual Magnification = Lens Optical Magnification × Digital Zoom Ratio). For example, the lens optical magnification is 2.8× and the digital zoom ratio is 2×, and the actual magnification is 5.6×.
 - The zoom ratio may vary according to different models. Please take the actual product for reference.
-

3.12 Flat Field Correction

This function can correct non-uniformity of display.

Steps

1. Press  to show the menu.
2. Go to  **Advanced Settings**, and press  or  to select .
3. Press  to enter the configuration interface.
4. Press  or  to switch FFC mode.
 - **Manual FFC:** Hold  in the live view to correct the non-uniformity of display.
 - **Auto FFC:** The device performs FFC automatically according to the set schedule when switching on the camera.
 - **External:** Cover the lens cover, then hold  in the live view to correct the non-uniformity of display.
5. Hold  to save the settings and exit.



Note

The countdown will start before the device performs FFC automatically.

3.13 Correct Defective Pixel

The device can correct the defective pixels on the screen which are not performed as expected.

Steps











1. Press  to show the menu.
2. Go to  **Advanced Settings**, and press  or  to select .
3. Press  to enter DPC configuration interface.
4. Press  to select **X** or **Y Axis**. If you select **X** axis, the cursor moves left and right; if you select **Y** axis, the cursor moves up and down.
5. Press  or  to set the coordinates until the cursor reaches the defective pixel.
6. Press  twice to correct the dead pixel.
7. Hold  to save the settings and exit.



Figure 3-5 Correct Defective Pixel









Note

- The selected defective pixel can be magnified and displayed on the bottom right of the interface.
 - If the screen OSD blocks the defective pixel, move the cursor to reach the defective pixel, then the device performs mirror display automatically.
-

3.14 Set Infrared Light

The infrared light helps to view targets clearly in dark environment. The infrared light only works in night mode, auto mode or when the environment is dark. In other modes, the infrared light does not take effect.

Steps

1. Press  to show the menu.
2. Press  or  to select  and press  to confirm.
3. Press  or  to select the light level or set smart IR.



Note

The image might be overexposed when the environment is too bright. The smart IR function adjusts the overexposed images by controlling infrared light intensity, so as to improve the image effect in night mode and dark environment.

4. Hold  to save settings and exit.



Note







- Infrared light cannot be turned on if the battery is low.
 - The infrared light is off in the thermal mode or standby mode.
-

3.15

WDR

WDR (Wide Dynamic Range) enhances the viewing experience by providing better image quality in diverse lighting conditions. When you enable this function, it prevents bright areas from appearing too bright and increases details in shadows.

Steps

1. Press  to show the menu.
2. Go to  **Advanced Settings**, and press  or  to select .
3. Press  to enable the function.
4. Hold  to save settings and exit.

Result







The visibility of the whole live view image will be enhanced.

3.16

Zoom Pro

Zoom Pro refers to zoomed image detail enhancement. When you turn on this function, the details of zoomed live view image will be enhanced.

Steps

1. Press  to show the menu.
2. Press  or  to select .
3. Press  to enable the function.
4. Hold  to save settings and exit.

Result

The details of the zoomed live view image will be enhanced.



Note

- This function may vary according to different models. Please take the actual product for reference.
 - If the PIP function is enabled, Zoom Pro is only enabled in the PIP view.
-















4 Measure Distance

The device can detect the distance between the target and the observation position with laser.

Before You Start

When measuring the distance, keep the hand and the position steady. Otherwise, the accuracy may be affected.

Steps

1. Press  to show the menu.
2. Go to  **Advanced Settings**, and press  or  to select .
3. Press  to go to the measurement interface. Go to  and press  or  to select a laser ranging mode. Press  to confirm. **Once** and **Continuous** are selectable.
 - **Continuous** means measuring the distance continuously, and the measurement duration can be selected. The measurement result will be refreshed every second.
 - **Once** means measuring the distance once.
4. (Optional) THD (True Horizontal Distance) can also be displayed on the live view interface when performing laser ranging. Select  and press  to enable the horizontal distance.
5. Hold  to save the settings and return to the live view interface.
6. Press  in the live view interface to turn on laser ranging, and aim the cursor at the target and press  again to measure the target distance.



Note

- Double press  in the live view interface to turn off laser ranging.
- Laser ranging cannot be enabled when device battery is low.

Result

The distance measurement result is displayed at the upper center of the image.



Figure 4-1 Laser Ranging Result

- When THD is enabled, the straight-line distance is displayed first, followed by the THD. As shown in the figure above, **28 m** is the straight-line distance and **26 m** is the THD.
- The ranging result will be displayed as "000" if laser ranging fails.



Caution

The laser radiation emitted from the device can cause eye injuries, burning of skin or inflammable substances. Before enabling the laser ranging function, make sure no human or inflammable substances are in front of the laser rangefinder.

















5 Ballistic Calculation for Hunting

The built-in ballistic calculator assists traditional scopes without ballistic calculation capability by computing the required clicks for precise aiming. Multiple parameters are used in calculation to ensure precision and flexibility of use.

Before You Start

Make sure you have finished zeroing on scope.

Steps

1. Press  to show the menu.
2. Go to  **Advanced Settings**, and press  or  to select  **Ballistic Calculation**. Press  to enter the setting interface.
3. Press  to enable this function.
4. Press  to select the **Ballistic Profile**.
5. Press  or  to select the following parameters, and press  to set or input the data.
 - **Drag Model:** Set the bullet-specific drag model, e.g. G1, G7, and GS.
 - **Unit:** Set this according to your preference for drop distance and measurement.
 - **Initial Velocity:** The velocity varies in different conditions.
 - **Altitude:** Set this to your normal altitude.
 - **Temperature:** Set this to your normal temperature.
 - **Ballistic Coefficient:** The measure of its ability to overcome air resistance.
 - **Sight Height:** The distance between the bore and the center of the lens.
 - **Zero Range:** The distance at which the scope is zeroed.
6. Press  to switch digit, and press  or  to change the number.
7. Hold  to save and exit.
8. Press  to turn on laser ranging, aim the cursor at the target, and press  again to measure the target distance. The screen will display the recommended aiming point and the drop distance in the upper right corner of the interface.
9. (Optional) To adjust the distance, repeat the above step.



Note











- This function may vary according to different models. Please take the actual product for reference.
 - The more parameters you specify, the more accurate the recommended aiming point will be.
 - The drop distance is related to the input parameters. Please refer to the actual situation.
 - Continuous laser ranging is not available when enabling ballistic calculation.
-

6 General Settings

6.1 Set OSD

This function can display or hide the OSD information on the live view interface.

Steps

1. Press  to show the menu.
2. Go to  **Advanced Settings**, and press  or  to select .
3. Press  to enter OSD setting interface.
4. Press  or  to select the **Time, Date, or OSD**, and press  to turn on or turn off the selected OSD information.
5. Hold  to save and exit.









Note

If you turn off **OSD**, all OSD information on the live view will not be displayed.

6.2 Set Brand Logo

You can add brand logo to the live view interface, snapshots, and videos.

Steps

1. Press  to show the menu.
2. Go to  **Advanced Settings**, and press  or  to select .
3. Press  to enable **Brand Logo**.
4. Hold  to save the settings and exit.







Result

The brand logo is displayed at the bottom left of the image.

6.3 Burning Prevention

Avoid direct sunlight and enable the burning prevention function to reduce the risk of sensor damage from the heat.

Steps

1. Press  to show the menu.
2. Go to  **Advanced Settings**, and press  or  to select .
3. Press  to enable or disable the function.
4. Hold  to save settings and exit.

6.4 Capture and Video

6.4.1 Capture Picture

In the live view interface, press  to capture picture.









Note

- When capturing succeeds, the image freezes for 1 second and a prompt shows on the display.
 - For exporting pictures, refer to *Export Files*.
-

6.4.2 Set Audio

If you turn on the audio function, the sound will be recorded with the video. When there is too loud noise in the video, you can turn off this function.

Steps

1. Press  to show the menu.
2. Go to  **Advanced Settings**, and press  or  to select .
3. Press  to enable or disable this function.
4. Hold  to save settings and exit.

6.4.3 Record Video

Steps

1. In the live view interface, hold  to start recording.



Figure 6-1 Start Recording





The left image displays the information of recording time.

2. Hold  again to stop recording.

6.4.4 View Local Album

Captured images and recorded videos are automatically stored in the device, and you can view the files in local albums.







Steps

1. Press  to go to the menu.
2. Go to  **Advanced Settings**, and press  or  to select .



Note



The albums are automatically created and named by year + month. The local pictures and videos of a certain month are stored in the corresponding album. For example, the pictures and videos of June in 2024 are saved in the album named 202406.





3. Press  or  to select the album storing the files, and press  to enter the selected album.
4. Press  or  to select a file to view.
5. Press  to view the selected file and relevant information.



Note

- Files are arranged in chronological order, with the most recent at the top. If you fails to find the most recently taken snapshots or videos,







please check the time and date settings of your device. When you are viewing files, you can switch to other files by pressing  or .

- When you are viewing files, you can press  to turn to next page, and press  to go back to previous page.
 - When you are viewing videos, you can press  to play or stop the video.
 - For deleting an album or a file, you can hold  to call the dialogue box, and delete the album or file according to the prompt.
-

6.5 Hot Tracking

The device can detect the highest temperature spot in the scene and mark it on display.

Steps

1. Press  to show the menu.
2. Go to  **Advanced Settings**, and press  or  to select .
3. Press  to mark the spot of highest temperature.

Result



When the function is enabled,  displays in the spot of highest temperature. When the scene changes, the  moves.



Figure 6-2 Hot Tracking

6.6 Export Files

6.6.1 Export Files via HIKMICRO Sight

You can access device albums and export files to your phone via HIKMICRO Sight.

Before You Start

Install HIKMICRO Sight on your mobile phone.

Steps

1. Open HIKMICRO Sight and connect your device to the app. See *App Connection*.
2. Tap **Media** to access device albums.

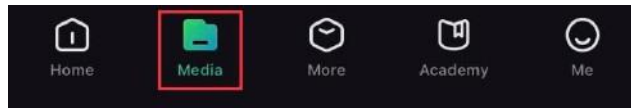

Figure 6-3 Access Device Albums

3. Tap **Local** or **Device** to view the photos and videos.
 - **Local:** You can view the files captured on app.
 - **Device:** You can view the files of the current device.



Note

The photos or videos may not show in **Device**. Please pull down to refresh the page.

4. Tap to select a file, and tap **Download** to export the file to your local phone albums.



Figure 6-4 Export Files



Note

- Go to **Me** -> **About** -> **User Manual** on the app to see more detailed operations.
 - You can also access device albums by tapping bottom left icon in the live view interface.
 - The exporting operation may vary due to app updates. Please take the actual app version for reference.
-









6.6.2 Export Files via PC

This function is used to export recorded videos and captured pictures.

Before You Start

Make sure the device is turned on when connecting the cable.

Steps

1. Press  to show the menu.
2. Go to  **Advanced Settings**, and press  or  to select .
3. Press  to enter the configuration interface.
4. Press  or  to select **USB Flash Drive**.
5. Connect the device and PC with cable.



Note

Make sure the device is turned on when connecting the cable.

6. Open computer disk and select the disk of device. Go to the DCIM folder and find the folder named after the capture year and month. For example, if you capture a picture or record a video on June 2024, go to **DCIM -> 202406** to find the picture or video.
7. Select and copy the files to PC.
8. Disconnect the device from your PC.



Note







- The device displays images when you connect it to PC. But functions such as recording, capturing and hotspot are disabled.
 - When you connect the device to PC for the first time, it installs the drive program automatically.
-

6.7 Direction Display

6.7.1 Switch on Compass

Equipped with a compass, the device can display its direction on the live image, captured images, and recorded videos.

Steps

1. Press  to show the menu.
2. Go to  **Advanced Settings**, and press  or  to select .
3. Select **Compass**, and press  to enable the function.
4. Follow the pop-up instructions to calibrate the compass. See *Calibrate Compass* for more information.

Result

After successful calibration, you can see the azimuth (AZM) angle and elevation (EL) angle displayed on the screen. It is recommended to read the information when you lay the device horizontally.

To increase the direction accuracy, you can set the magnetic declination correction. See *Magnetic Declination Correction* for instructions.



6.7.2 Calibrate Compass

Compass calibration is a must for correction direction display. You need to calibrate the compass when you enable the function for the first time, or when the compass is magnetically interfered.



Figure 6-5 Compass Interference

Steps

1. Call the calibration guide by the following ways.
 - When you enable compass for the first time, the compass calibration guide pops up.
 - When the compass information appears in red, select  in the menu and press  to restart calibrating compass.
2. Follow the screen instructions to move and rotate the device.

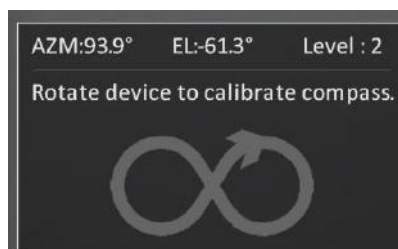

Figure 6-6 Calibrate Compass



Note

- During calibration, keep moving and rotating the device to make sure that the device faces every possible directions.
 - **Level** indicates the validity of calibration. Higher level means more accurate compass reading. Calibration succeeds when **Level** turns to **3**.
-

3. Stop moving the device when calibration success message pops up.

Result

The direction information is displayed on the live view interface.











Figure 6-7 Direction Display

6.7.3 Magnetic Declination Correction

Magnetic declination is the angle variation between magnetic north and true north. Adding the magnetic declination to the compass increases the accuracy of direction reading.

Steps

1. After the compass is calibrated, go to the compass setting interface, and press  or  to select **Magnetic Declination**.
2. Press  to enter the setting interface, and press  or  to select **Quick Correction** or **Manual Correction**.
 - In quick correction, the device displays the current declination to magnetic north. Point screen center to true north and press  to confirm.
 - In manual correction, press  to select the operational symbol or number, and press  or  to add or subtract the declination of device location.

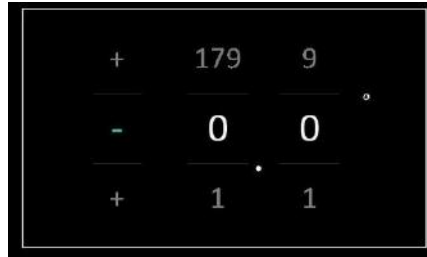

Figure 6-8 Manual Correction

3. Hold to save and exit.



Note

It is recommended to check the local magnetic declination information on the authorized website before manually correcting the magnetic declination. The eastern magnetic declination is indicated with a positive mark (+), and the western declination is indicated with a negative mark (-).

6.8 Geographic Location Display



Note

- The satellite module is unable to receive signals when the device is indoor. Place the device in an empty outdoor space to receive signals.
 - In the outdoors, wait for a moment for the device to display its location.
 - Equipped with satellite positioning modules, the device is able to display the longitude and latitude of the device on the live image, captured images, and recorded videos.
-

Steps

1. Press to show the menu.
2. Go to **Advanced Settings**, and press or to select .
3. Press to enable GPS. You can see the location displayed at the lower right corner of the screen.



Figure 6-9 Device Location Display

If the location information displays the information “Weak Signal”, it indicates the signal is weak or no signal. Please move to the open outdoor space to try again.













Figure 6-10 Weak Signal

7 System Settings















7.1 Adjust Date

Steps

1. Press  to show the menu.
2. Go to  **Advanced Settings**, and press  or  to select .
3. Press  to enter the configuration interface.
4. Press  to select the year, month, or day, and press  or  to change the number.
5. Hold  to save settings and exit.

7.2 Synchronize Time







Step





1. Press  to show the menu.
2. Go to  **Advanced Settings**, and press  or  to select .
3. Press  to enter the configuration interface.
4. Press  or  to switch the clock system. 24-hour and 12-hour clock are selectable. If you select 12-hour clock, press , and then press  or  to select **AM** or **PM**.
5. Press  to select the hour or minute, and press  or  to change the number.
6. Hold  to save settings and exit.

7.3 Set Language

You can select the device language in this function.

Steps









1. Press  to show the menu.
2. Go to  **Advanced Settings**, and press  or  to select .
3. Press  to enter the language configuration interface.

4. Press  or  to select the language as required, and press  to confirm.
5. Hold  to save settings and exit.

7.4 Cast Device Screen to PC

The device supports casting screen to PC by UVC protocol-based client software or player. You can view the device image on the display for details.









Steps

1. Press  to show the menu.
2. Go to  **Advanced Settings**, and press  or  to select .
3. Press  to enter the configuration interface.
4. Press  or  to select **Digital**.
5. Hold  to save settings and exit.
6. Open the UVC protocol-based client software, and use a type-C cable to connect your device with PC.

7.5 Set Unit

You can switch the unit for distance measurement.







Steps

1. Press  to show the menu.
2. Go to  **Advanced Settings**, and press  or  to select .
3. Press  to enter the unit setting interface. Press  or  to select the unit as required.
4. Hold  to save settings and exit.

7.6 Save Diagnostic Log

This function helps to collect and save device operation logs for troubleshooting.

Steps

1. Press  to show the menu.
2. Go to  **Advanced Settings**, and press  or  to select .
3. Press  to enable the function. The device will start to collect and record the device log.
4. Press  to disable the function when the diagnostic log collection is finished.



Note











- When disabling the diagnostic log, a prompt will appear on the interface indicating the progress of diagnostic log collection. This operation cannot be interrupted. Once the log collection is finished, the prompt will disappear.
 - If you need to send the logs to the professionals, find and export the log package files (*.tar.gz) stored in the log folder in the root directory of the device. See *Export Files via PC*.
 - The log package files (*.tar.gz) are generated only when Diagnostic Log is enabled and disabled afterwards. If the function is kept on, only *.log files will be saved in the log folder.
-

7.7 Set Screen Lock Passcode

You can set a passcode to lock the device screen to avoid unauthorized access to the device.



7.7.1 Enable Passcode

Steps

1. Press  to show the menu.
2. Go to  **Advanced Settings**, and press  or  to select .
3. Press  to enable this function and enter the configuration interface.
4. Press  to switch digit, and press  or  to change the number.
5. Hold  to save settings and exit.

Result

When passcode is enabled, you need to enter the passcode when the device is powered on or woken up from standby mode. Press  to

switch digit, press  or  to change the number, and hold  to confirm.

















Note

If you forget the passcode, you can hold  to reset it on the lock screen. This operation requires a factory reset to the device.

7.7.2 Change Passcode







You can change the passcode as needed when it is enabled.

Steps

1. Press  to show the menu.
2. Go to  **Advanced Settings**, and press  or  to select .
3. Press  to enter the configuration interface.
4. Press  or  to select , and press  to enter the configuration interface.
5. Press  to switch digit, and press  or  to change the number.
6. Hold  to save settings and exit.





7.8 View Device Information

Steps

1. Press  to show the menu.
2. Go to  **Advanced Settings**, and press  or  to select .
3. Press  to confirm. You can view the device information such as available storage space, version, and serial No.
4. Hold  to save settings and exit.

7.9 Format

Steps

1. Press  to show the menu.
2. Go to  **Advanced Settings**, and press  or  to select .

3. Press  to format the device storage according to the prompt.









Note

When selecting , the device automatically shows the remaining storage.

7.10 Restore Device

This function only restores the device basic settings, such as brightness and contrast to their defaults.







Steps

1. Press  to show the menu.
2. Go to  **Advanced Settings**, and press  or  to select .
3. Press  to restore the device to defaults according to the prompt.

7.11 Reset Device

This function erases all content and settings, including basic settings, storage, passcode, and hotspot password.

Steps

1. Press  to show the menu.
2. Go to  **Advanced Settings**, and press  or  to select .
3. Press  to restore the device to defaults according to the prompt.

8 Frequently Asked Questions

8.1 Why does the charge indicator flash improperly?

Check the following items.

- Check whether the device is charged with standard power adapter and the charging temperature is above 0 °C (32 °F).
- Charge the device in power off status.

8.2 Why is the power indicator off?

Check whether the device is off-battery. Check the indicator after charging the device for 5 minutes.

8.3 The image is not clear, how to adjust it?

Adjust the diopter adjustment ring or focus ring until the image is clear. Refer to *Adjust Device*.

8.4 Capturing or recording fails. What's the problem?

Check the following items.

- Whether the device is connected to your PC. Capturing or recording is disabled in this status.
- Whether the storage space is full.
- Whether the device is low-battery.

8.5 Why the PC cannot identify the device?

Check the following items.

- Whether the device is connected to your PC with supplied USB cable.
- If you use other USB cables, make sure the cable length is no longer than 1 m.
- Check whether the USB connection mode is switched to **USB Flash Drive**.

Legal Information

© Hangzhou Microimage Software Co., Ltd. All rights reserved.

About this Manual

The Manual includes instructions for using and managing the Product. Pictures, charts, images and all other information hereinafter are for description and explanation only. The information contained in the Manual is subject to change, without notice, due to firmware updates or other reasons. Please find the latest version of this Manual at the HIKMICRO website (www.hikmicrotech.com/).

Please use this Manual with the guidance and assistance of professionals trained in supporting the Product.

Trademarks Acknowledgement

 **HIKMICRO** and other HIKMICRO's trademarks and logos are the properties of HIKMICRO in various jurisdictions.

Other trademarks and logos mentioned are the properties of their respective owners.

LEGAL DISCLAIMER

TO THE MAXIMUM EXTENT PERMITTED BY APPLICABLE LAW, THIS MANUAL AND THE PRODUCT DESCRIBED, WITH ITS HARDWARE, SOFTWARE AND FIRMWARE, ARE PROVIDED "AS IS" AND "WITH ALL FAULTS AND ERRORS". HIKMICRO MAKES NO WARRANTIES, EXPRESS OR IMPLIED, INCLUDING WITHOUT LIMITATION, MERCHANTABILITY, SATISFACTORY QUALITY, OR FITNESS FOR A PARTICULAR PURPOSE. THE USE OF THE PRODUCT BY YOU IS AT YOUR OWN RISK. IN NO EVENT WILL HIKMICRO BE LIABLE TO YOU FOR ANY SPECIAL, CONSEQUENTIAL, INCIDENTAL, OR INDIRECT DAMAGES, INCLUDING, AMONG OTHERS, DAMAGES FOR LOSS OF BUSINESS PROFITS, BUSINESS INTERRUPTION, OR LOSS OF DATA, CORRUPTION OF SYSTEMS, OR LOSS OF DOCUMENTATION, WHETHER BASED ON BREACH OF CONTRACT, TORT (INCLUDING NEGLIGENCE), PRODUCT LIABILITY, OR OTHERWISE, IN CONNECTION WITH THE USE OF THE PRODUCT, EVEN IF HIKMICRO HAS BEEN ADVISED OF THE POSSIBILITY OF SUCH DAMAGES OR LOSS.

YOU ACKNOWLEDGE THAT THE NATURE OF THE INTERNET PROVIDES FOR INHERENT SECURITY RISKS, AND HIKMICRO SHALL NOT TAKE ANY

RESPONSIBILITIES FOR ABNORMAL OPERATION, PRIVACY LEAKAGE OR OTHER DAMAGES RESULTING FROM CYBER-ATTACK, HACKER ATTACK, VIRUS INFECTION, OR OTHER INTERNET SECURITY RISKS; HOWEVER, HIKMICRO WILL PROVIDE TIMELY TECHNICAL SUPPORT IF REQUIRED.

YOU AGREE TO USE THIS PRODUCT IN COMPLIANCE WITH ALL APPLICABLE LAWS, AND YOU ARE SOLELY RESPONSIBLE FOR ENSURING THAT YOUR USE CONFORMS TO THE APPLICABLE LAW. ESPECIALLY, YOU ARE RESPONSIBLE, FOR USING THIS PRODUCT IN A MANNER THAT DOES NOT INFRINGE ON THE RIGHTS OF THIRD PARTIES, INCLUDING WITHOUT LIMITATION, RIGHTS OF PUBLICITY, INTELLECTUAL PROPERTY RIGHTS, OR DATA PROTECTION AND OTHER PRIVACY RIGHTS. YOU SHALL NOT USE THIS PRODUCT FOR ILLEGAL HUNTING ANIMALS, INVASION OF PRIVACY OR ANY OTHER PURPOSE WHICH IS ILLEGAL OR DETRIMENTAL TO THE PUBLIC INTEREST. YOU SHALL NOT USE THIS PRODUCT FOR ANY PROHIBITED END-USES, INCLUDING THE DEVELOPMENT OR PRODUCTION OF WEAPONS OF MASS DESTRUCTION, THE DEVELOPMENT OR PRODUCTION OF CHEMICAL OR BIOLOGICAL WEAPONS, ANY ACTIVITIES IN THE CONTEXT RELATED TO ANY NUCLEAR EXPLOSIVE OR UNSAFE NUCLEAR FUEL-CYCLE, OR IN SUPPORT OF HUMAN RIGHTS ABUSES.

PLEASE FOLLOW ALL THE PROHIBITIONS AND EXCEPTIONAL CAVEATS OF ALL APPLICABLE LAWS AND REGULATIONS, IN PARTICULAR, THE LOCAL FIREARMS AND/OR HUNTING LAWS AND REGULATIONS. PLEASE ALWAYS CHECK NATIONAL PROVISIONS AND REGULATIONS BEFORE PURCHASE OR USE OF THIS PRODUCT. PLEASE NOTE THAT YOU MAY HAVE TO APPLY FOR PERMITS, CERTIFICATES, AND/OR LICENSES BEFORE ANY PURCHASING, SELLING, MARKETING AND/OR USING OF THE PRODUCT. HIKMICRO SHALL NOT BE LIABLE FOR ANY SUCH ILLEGAL OR IMPROPER PURCHASING, SELLING, MARKETING, AND END USES AND ANY SPECIAL, CONSEQUENTIAL, INCIDENTAL, OR INDIRECT DAMAGES ARISING THEREOF.

IN THE EVENT OF ANY CONFLICTS BETWEEN THIS MANUAL AND THE APPLICABLE LAW, THE LATTER PREVAILS.

Regulatory Information

These clauses apply only to the products bearing the corresponding mark or information.

EU Conformity Statement



This product and - if applicable - the supplied accessories too are marked with "CE" and comply therefore with the applicable harmonized European standards listed under the Directive 2014/30/EU (EMCD), Directive 2014/35/EU (LVD), Directive 2011/65/EU (RoHS), Directive 2014/53/EU.

Hereby, Hangzhou Microimage Software Co., Ltd. declares that this device (refer to the label) is in compliance with Directive 2014/53/EU.

The full text of the EU declaration of conformity is available at the following internet address:

<https://www.hikmicrotech.com/en/support/download-center/declaration-of-conformity/>

Frequency Bands and Power (for CE)

The frequency bands and transmitting power (radiated and/or conducted) nominal limits applicable to the following radio equipment are as follows:

Wi-Fi 2.4 GHz (2.4 GHz to 2.4835 GHz), 20 dBm

5 GHz (5.15 GHz to 5.25 GHz): 23 dBm

5.15 to 5.25 GHz Indoor use only.

For the device without a supplied power adapter, use the power adapter provided by a qualified manufacturer. Refer to the product specification for detailed power requirements.

For the device without a supplied battery, use the battery provided by a qualified manufacturer. Refer to the product specification for detailed battery requirements.



Directive 2012/19/EU (WEEE Directive): Products marked with this symbol cannot be disposed of as unsorted municipal waste in the European Union. For proper recycling, return this product to your local supplier upon the purchase of equivalent new equipment, or dispose of it at designated collection points. For more information see: www.recyclethis.info

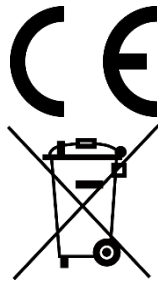

Regulation (EU) 2023/1542 (Battery Regulation): This product contains a battery and it is in conformity with the Regulation (EU) 2023/1542. The battery cannot be disposed of as unsorted municipal waste in the European Union. See the product documentation for specific battery information. The battery is marked with this symbol, which may include lettering to indicate cadmium (Cd), or lead (Pb). For proper recycling, return the battery to your supplier or to a designated collection point. For more information see: www.recyclethis.info.

KC

B 급 기기: 이 기기는 가정용(B 급) 전자파적합기기로서 주로 가정에서 사용하는 것을 목적으로 하며, 모든 지역에서 사용할 수 있습니다.

INFORMATIONEN FÜR PRIVATE HAUSHALTE

1. Getrennte Erfassung von Altgeräten:

Elektro- und Elektronikgeräte, die zu Abfall geworden sind, werden als Altgeräte bezeichnet. Besitzer von Altgeräten haben diese einer vom unsortierten Siedlungsabfall getrennten Erfassung zuzuführen. Altgeräte gehören insbesondere nicht in den Hausmüll, sondern in spezielle Sammel- und Rückgabesysteme.

2. Batterien und Akkus sowie Lampen:

Besitzer von Altgeräten haben Altbatterien und Altakkumulatoren, die nicht vom Altgerät umschlossen sind, die zerstörungsfrei aus dem Altgerät entnommen werden können, im Regelfall vor der Abgabe an einer Erfassungsstelle vom Altgerät zu trennen. Dies gilt nicht, soweit Altgeräte einer Vorbereitung zur Wiederverwendung unter Beteiligung eines öffentlich-rechtlichen Entsorgungsträgers zugeführt werden.

3. Möglichkeiten der Rückgabe von Altgeräten:

Besitzer von Altgeräten aus privaten Haushalten können diese bei den Sammelstellen der öffentlich-rechtlichen Entsorgungsträger oder bei den von Herstellern oder Vertreibern im Sinne des ElektroG eingerichteten Rücknahmestellen unentgeltlich abgeben. Rücknahmepflichtig sind Geschäfte mit einer Verkaufsfläche von mindestens 400 m² für Elektro- und Elektronikgeräte sowie diejenigen Lebensmittelgeschäfte mit einer Gesamtverkaufsfläche von mindestens 800 m², die mehrmals pro Jahr oder dauerhaft Elektro- und Elektronikgeräte anbieten und auf dem Markt bereitstellen. Dies gilt auch bei Vertrieb unter Verwendung von Fernkommunikationsmitteln, wenn die Lager- und Versandflächen für

Elektro- und Elektronikgeräte mindestens 400 m² betragen oder die gesamten Lager- und Versandflächen mindestens 800 m² betragen. Vertreiber haben die Rücknahme grundsätzlich durch geeignete Rückgabemöglichkeiten in zumutbarer Entfernung zum jeweiligen Endnutzer zu gewährleisten. Die Möglichkeit der unentgeltlichen Rückgabe eines Altgerätes besteht bei rücknahmepflichtigen Vertreibern unter anderem dann, wenn ein neues gleichartiges Gerät, das im Wesentlichen die gleichen Funktionen erfüllt, an einen Endnutzer abgegeben wird.

4. Datenschutz-Hinweis:

Altgeräte enthalten häufig sensible personenbezogene Daten. Dies gilt insbesondere für Geräte der Informations- und Telekommunikationstechnik wie Computer und Smartphones. Bitte beachten Sie in Ihrem eigenen Interesse, dass für die Löschung der Daten auf den zu entsorgenden Altgeräten jeder Endnutzer selbst verantwortlich ist.



5. Bedeutung des Symbols „durchgestrichene Mülltonne“:



Das auf Elektro- und Elektronikgeräten regelmäßig abgebildete Symbol einer durchgestrichenen Mülltonne weist darauf hin, dass das jeweilige Gerät am Ende seiner Lebensdauer getrennt vom unsortierten Siedlungsabfall zu erfassen ist.

Symbol Conventions

The symbols that may be found in this document are defined as follows.

Symbol	Description
 Note	Provides additional information to emphasize or supplement important points of the main text.
 Caution	Indicates a potentially hazardous situation, which if not avoided, could result in equipment damage, data loss, performance degradation, or unexpected results.
 Danger	Indicates a hazard with a high level of risk, which if not avoided, will result in death or serious injury.

Safety Instruction

These instructions are intended to ensure that user can use the product correctly to avoid danger or property loss. Please read all the safety information carefully before using.

Transportation

- Keep the device in original or similar packaging while transporting it.
- Keep all wrappers after unpacking them for future use. In case of any failure occurred, you need to return the device to the factory with the original wrapper. Transportation without the original wrapper may result in damage on the device and the company shall not take any responsibilities.
- Do not drop the product or subject it to physical shock. Keep the device away from magnetic interference.

Power Supply

- If a power adapter is provided in the device package, use the provided adapter only. If no power adapter is provided, ensure the power adapter or other power supply complies with Limited Power Source. Refer to the product label for the power supply output parameters.
- Make sure the plug is properly connected to the power socket.
- DO NOT connect multiple devices to one power adapter, to avoid overheating or fire hazards caused by overload.
- The power delivered by the charger must be between min. 14 Watts required by the radio equipment, and max. 27 Watts in order to achieve the maximum charging speed. The device supports USB PD fast charging.

Battery

- The device supports removable rechargeable li-ion battery, and the battery size should be 86 mm × 48 mm. The battery rated voltage and capacity is 7.2 V/4800 mAh.
- For long-term storage of the battery, make sure it is fully charged every 3 months to ensure the battery quality. Otherwise, damage may occur.
- CAUTION: Risk of explosion if the battery is replaced by an incorrect type.
- The purchased batteries by users need to comply with the relevant international standards about battery safety (e.g. EN/IEC standards).
- The built-in battery cannot be dismantled. Please contact the manufacture for repair if necessary.

- Make sure the battery temperature is between 0 °C to 50 °C (32 °F to 122 °F) when charging.
- Batteries of improper size cannot be installed, and may cause abnormal shutdown.
- CAUTION: Risk of explosion if the battery is replaced by an incorrect type. Replace with the same or equivalent type only.
- Improper replacement of the battery with an incorrect type may defeat a safeguard (for example, in the case of some lithium battery types).
- Do not dispose of the battery into fire or a hot oven, or mechanically crush or cut the battery, which may result in an explosion.
- Do not leave the battery in an extremely high temperature surrounding environment, which may result in an explosion or the leakage of flammable liquid or gas.
- Do not subject the battery to extremely low air pressure, which may result in an explosion or the leakage of flammable liquid or gas.
- Dispose of used batteries according to the instructions.
- Confirm there is no flammable material within 2 m of the charger during charging.
- DO NOT place the battery in the reach of children.
- DO NOT swallow the battery to avoid chemical burns.
- This product contains a coin/button cell battery. If the coin/button cell battery is swallowed, it can cause severe internal burns in just 2 hours and can lead to death.
- If the battery compartment does not close securely, stop using the product and keep it away from children.
- If you think batteries might have been swallowed or placed inside any part of the body, seek immediate medical attention.
- DO NOT place the device with battery or the battery alone near heating or fire source. Avoid direct sunlight.
- CAUTION: Risks of short circuit, fire, or explosion if the battery is damaged. Frequent use, dropping, impact, corrosion, or compression of the battery may cause damages including cracked casing, detached plates, or leakage of internal liquid or gas, etc.
- If the battery is damaged, stop using it immediately and dispose of it according to the instructions.

Maintenance

- If the product does not work properly, please contact your dealer or the nearest service center. We shall not assume any responsibility for problems caused by unauthorized repair or maintenance.
- Make sure that the power has been disconnected before device teardown and repair by professionals.

- If the equipment is used in a manner not specified by the manufacturer, the protection provided by the device may be impaired.
- Check the optical surfaces of objective lens, eyepiece, rangefinder, etc. If necessary, remove dust and sand from the optics using tools and solvent designed especially for this purpose (it is preferable to use a non-contact method).
- Wipe the exterior surfaces of metal, plastic, and silicone parts with a clean and soft cloth. Do not use chemically active substances, solvents, etc. as these may damage the paint.
- Clean the electrical contacts of the removable battery on the device using a non-greasy organic solvent.

Using Environment

- Make sure the running environment meets the requirement of the device. The operating temperature shall be -30 °C to 55 °C (-22 °F to 131 °F), and the operating humidity shall be from 5% to 95%.
- DO NOT expose the device to high electromagnetic radiation or dusty environments.
- DO NOT aim the screen at the sun or any other bright light.
- Place the device in a dry and well-ventilated environment.
- Avoid equipment installation on vibratory surface or places subject to shock (neglect may cause equipment damage).
- This equipment is not suitable for use in locations where children are likely to be present.

Emergency

If smoke, odor, or noise arises from the device, immediately turn off the power, unplug the power cable, and contact the service center.

Laser

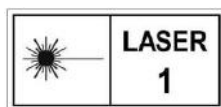

When any laser equipment is in use, make sure that the device lens is not exposed to the laser beam, or it may burn out. The laser radiation emitted from the device can cause eye injuries, burning of skin or inflammable substances. Before enabling the laser ranging function, make sure no human or inflammable substances are in front of the laser lens. Do not place the device where minors can fetch it. The wavelength is 905 nm, the pulse duration is 52 ns, and the max. power output is less than 2.2 mW. According to IEC 60825-1:2014, EN 60825-1:2014+A11:2021, and EN 50689:2021, this laser product is classified as Class 1 laser product and consumer laser product.

Limited Warranty

Scan the QR code for the product warranty policy.



Manufacture Address

Room 313, Unit B, Building 2, 399 Danfeng Road, Xixing Subdistrict,
Binjiang District, Hangzhou, Zhejiang 310052, China

Hangzhou Microimage Software Co., Ltd.

COMPLIANCE NOTICE: The thermal series products might be subject to export controls in various countries or regions, including without limitation, the United States, European Union, United Kingdom and/or other member countries of the Wassenaar Arrangement. Please consult your professional legal or compliance expert or local government authorities for any necessary export license requirements if you intend to transfer, export, re-export the thermal series products between different countries.



 Hikmicro Hunting.Global

 HIKMICRO Outdoor

 www.hikmicrotech.com

 Hikmicro Hunting.Global

 HIKMICRO Hunting.Global

 support@hikmicrotech.com

UD44798B