

User Manual

Thermal Monocular

LYNX 3.0 SERIES

V6.0.4 202510



Contact Us

CONTENTS

1	Overview	1
1.1	Main Function	1
1.2	Appearance	1
2	Preparation	4
2.1	Install Battery	4
2.1.1	Battery Instruction	4
2.1.2	Battery Installation	4
2.2	Cable Connection	5
2.3	Power On/Off	5
2.4	Auto Screen Off	6
2.5	Menu Description	7
2.6	App Connection	8
2.7	Firmware Status	9
2.7.1	Check Firmware Status	9
2.7.2	Upgrade Device	9
3	Image Settings	11
3.1	Adjust Diopter	11
3.2	Adjust Focus	11
3.3	Adjust Brightness	12
3.4	Adjust Contrast	12
3.5	Adjust Tone	12
3.6	Adjust Sharpness	13
3.7	Select Scene	13
3.8	Set Palettes	13
3.8.1	Custom Enabled Palettes	13
3.8.2	Switch Palettes	14
3.9	Set Picture in Picture Mode	16
3.10	Adjust Digital Zoom	17
3.11	Correct Defective Pixel	17
4	Measure Distance	19
5	General Settings	20
5.1	Set OSD	20
5.2	Set Brand Logo	20
5.3	Set Screen Style	20
5.4	Burning Prevention	21
5.5	Capture and Video	21
5.5.1	Capture Picture	21
5.5.2	Set Audio	21
5.5.3	Record Video	22
5.5.4	View Local Files	22
5.6	Hot Tracking	23
5.7	Export Files	24

Thermal Monocular User Manual

5.7.1	Export Files via HIKMICRO Sight	24
5.7.2	Export Files via PC.....	25
6	System Settings	26
6.1	Adjust Date	26
6.2	Synchronize Time	26
6.3	Set Language.....	26
6.4	Cast Device Screen to PC.....	27
6.5	Set Unit.....	27
6.6	Set Screen Lock Passcode.....	27
6.6.1	Enable Passcode.....	27
6.6.2	Change Passcode	28
6.7	View Device Information	28
6.8	Restore Device.....	28
6.9	Reset Device	29
7	Frequently Asked Questions	30
7.1	Why does the charge indicator flash improperly?.....	30
7.2	Why is the power indicator off?.....	30
7.3	The image is not clear, how to adjust it?	30
7.4	Capturing or recording fails. What's the problem?.....	30
7.5	Why the PC cannot identify the device?	30

1 Overview

HIKMICRO LYNX 3.0 is a compact and lightweight thermal monocular designed for portability and ease of use. With enhanced image quality powered by higher thermal sensitivity and AI-powered image algorithms, it ensures exceptional clarity and detailed recognition, even in challenging weather conditions, day or night. Well suited for hunting, birding, wildlife observation, and search-and-rescue missions, it sets a new standard for performance and reliability.

1.1 Main Function

- **Image Pro 3.0:** Featured with Image Pro 3.0 imaging algorithm, LYNX 3.0 delivers minimal details of animals' characteristics and layered backgrounds with less noise.
- **HSIS (HIKMICRO Shutterless Image System):** LYNX 3.0 supports shutterless technology, it is a dynamic learning process without image quality loss. This eliminates the need for periodic calibration pauses, ensuring you never miss a critical moment in the field.
- **Local Album:** Local album stores captured images and recoil-activated videos, which help you clarify whether you get the game immediately.
- **Video and Snapshot:** The built-in memory module supports video recording and snapshot capturing.
- **App Connection:** The device can capture snapshots, record videos, and set parameters by HIKMICRO Sight app after being connected to your phone via hotspot.
- **Zoom Pro:** This function enhances the details of zoomed live view images, allowing for clearer and more refined visuals.

1.2 Appearance



Note

- The appearance may vary according to different models. Please take the actual product for reference.
 - Pictures in this manual are for illustration purpose only. Please take the actual product for reference.
-

Thermal Monocular User Manual

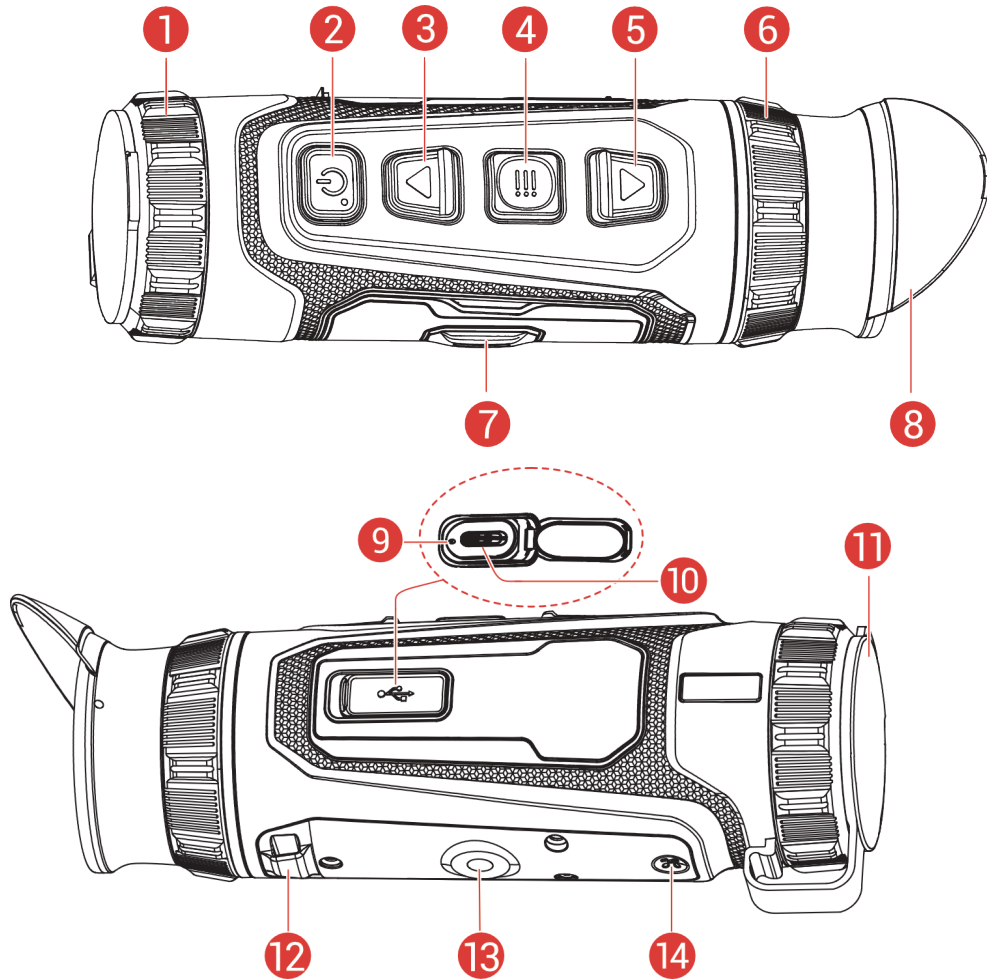





Figure 1-1 Appearance

Table 1-1 Description of Buttons and Components

No.	Component	Description
1	Focus Ring	Adjusts focus to obtain clear targets.
2	 Power Key	<ul style="list-style-type: none"> ● Press: Standby mode/Wake up device. ● Hold: Power on/off.
3	 Up Key	Non-Menu Mode: <ul style="list-style-type: none"> ● Press: Capture snapshots. ● Hold: Start/Stop recording videos. Menu Mode: Move up.
4	 Mode Key	Non-Menu Mode: <ul style="list-style-type: none"> ● Press: Switch palettes. ● Hold: Enter the menu. Menu Mode: <ul style="list-style-type: none"> ● Press: Confirm/Set parameters. ● Hold: Save and exit menu.
5	 Down Key	Non-Menu Mode: <ul style="list-style-type: none"> ● Press: Switch digital zoom.

Thermal Monocular User Manual

		<ul style="list-style-type: none">● Hold: Correct non-uniformity of display (FFC). Menu Mode: Move down.
6	Diopter Adjustment Ring	Adjusts the dioptic setting.
7	Battery Compartment	For holding the battery.
8	Eyepiece	The piece placed closest to the eye to view the target.
9	Charging Indicator	Indicates the charging status of the device. <ul style="list-style-type: none">● Flashing Red & Green: Error occurred.● Solid Red: Charging.● Solid Green: Fully charged.
10	Type-C Interface	Power the device or transmit data with a type-C cable.
11	Lens Cover	Protects the lens.
12	Wrist Strap Hole	Mounts the wrist strap.
13	Tripod Mount	Mounts the tripod.
14	Microphone	To record audio.



Note

- The power indicator stays solid red when the device is on.
 - When the auto screen off function is enabled, if you press  to enter standby mode, you can also tilt or rotate the device to wake up the device. Refer to ***Auto Screen Off*** for detailed operation.
-

2 Preparation

2.1 Install Battery

2.1.1 Battery Instruction

- Remove the external battery if the device is not used for a long time.
- The external rechargeable battery type is 18650, and the battery size should be 19 mm × 70 mm. The rated voltage is 3.635 V, and the battery capacity is 3300 mAh.
- To ensure better conductivity, if the battery compartment cover gets dirty, use a clean cloth to wipe the thread.

2.1.2 Battery Installation

Insert the battery into the battery compartment.

Steps

1. Slide the battery compartment cover lock, as the arrow shows.

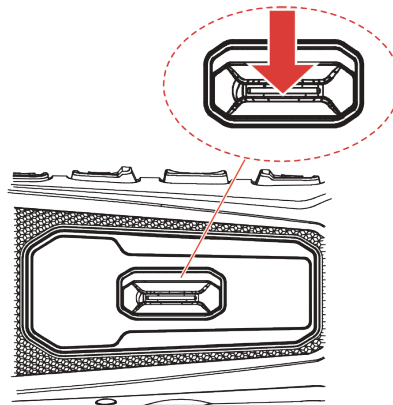

Figure 2-1 Unlock the Cover

2. Open the cover and insert the battery into the battery compartment as the positive and negative marks indicate.

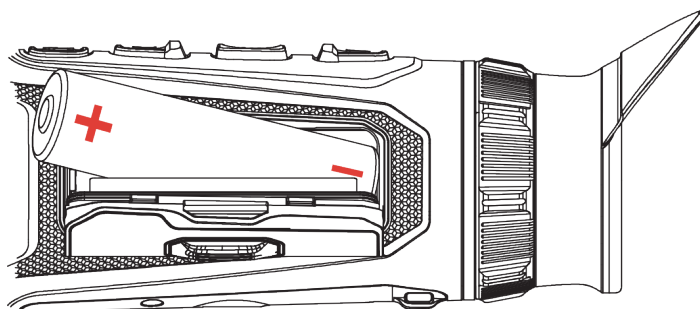

Figure 2-2 Insert the Battery

3. Close the battery compartment cover and lock it.

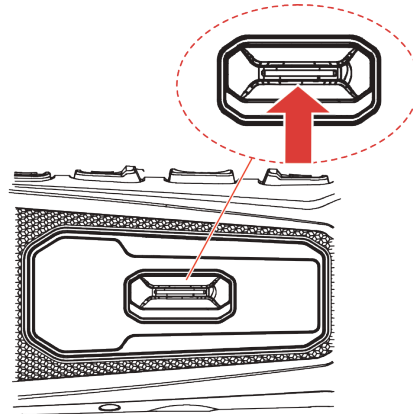

Figure 2-3 Close the Cover

2.2 Cable Connection

Before You Start

Make sure the battery is installed in the device.

Connect the device and power adaptor with a type-C cable to charge the device. Alternatively, connect the device and PC to export files.

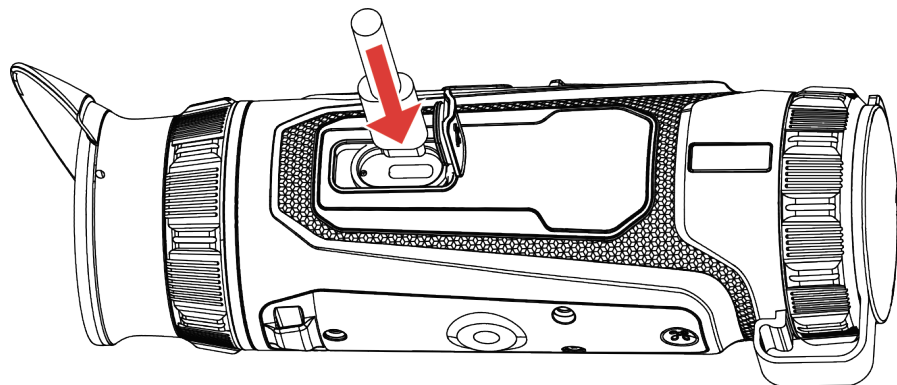

Figure 2-4 Cable Connection



Note

- Charge the device for more than 4 hours before first use.
 - You can also use the battery charger to charge the battery.
 - The charging temperature should be from 0 °C to 55°C (32 °F to 131 °F).
-

2.3 Power On/Off

Power On

When the device is connected to cable or the battery is enough, hold  to power on the device.

Power Off

When the device is turned on, hold  to power off the device.













Note

- Power-off countdown will appear when you power off the device. You can press any key to interrupt the countdown and cancel the power-off.
 - Automatic low battery power-off cannot be canceled.
-

Auto Power Off



You can set the auto power off time for your device.

Steps

1. Hold  to show the menu.
 2. Go to  **Advanced Settings**, and press  or  to select .
 3. Press  to enter the configuration interface.
 4. Press  or  to select the auto power off time as required, and press  to confirm.
 5. Hold  to save and exit.
-











Note

- See the battery icon for the battery status.  means the battery is fully charged,  means that the battery is low, and  means the battery charging is abnormal.
 - When the low power note shows, charge the battery.
 - The auto power off takes effect only when the device enters the standby mode and the device isn't connected with HIKMICRO Sight app at the same time.
 - The auto power off countdown will start again when the device reenters standby mode, or the device is restarted.
-

2.4 Auto Screen Off

Auto screen off function darkens the screen to save energy and increase battery time.

Steps

1. Enable auto screen off.
 - 1) Hold  to show the menu.
 - 2) Go to  **Advanced Settings**, and press  or  to select .
 - 3) Press  to enable auto screen off.
 - 4) Hold  to save settings and exit.
2. You can do one of the following methods to enter the standby mode when the display is turned on:
 - Tilt the device downwards more than 70°.
 - Rotate the device horizontally more than 75°.
 - Keep the device still and do not move it for 5 minutes.
3. You can do one of the following methods to wake up the device when the display is turned off:
 - Tilt the device downwards from 0° to 60° or upwards.
 - Rotate the device horizontally from 0° to 75°.
 - Press  to wake up the device.



Note

After enabling the auto screen off, when you enter the menu, the auto screen off does not take effect until you exit the menu.

2.5 Menu Description

In the live view interface, hold  to show the menu.

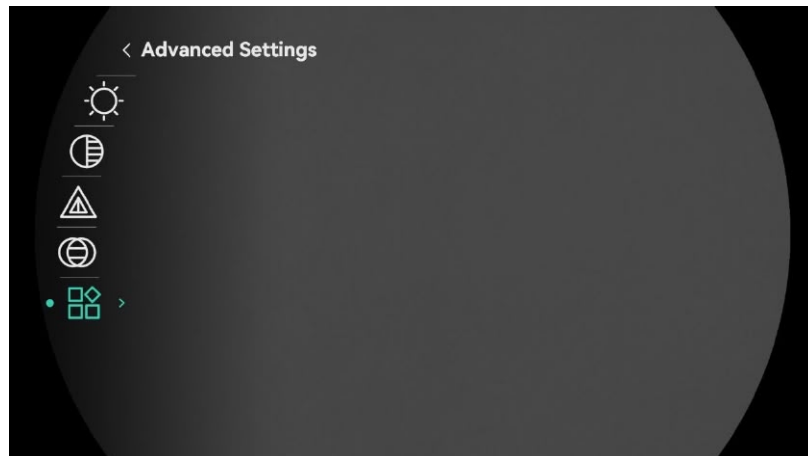

Figure 2-5 Menu Description (Round)

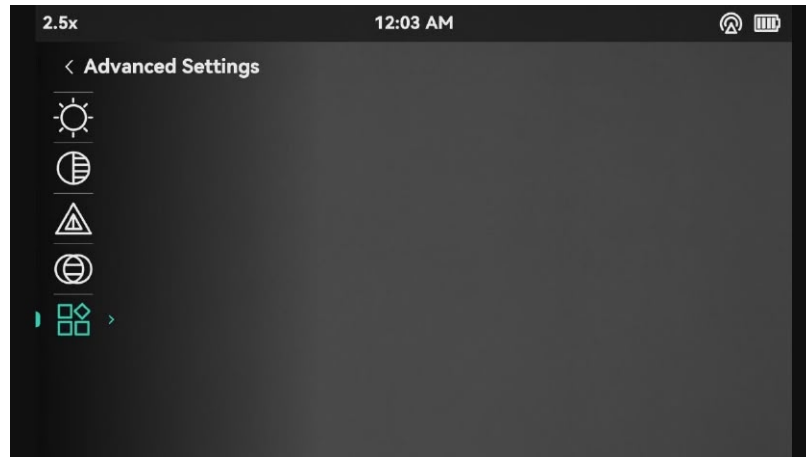



Figure 2-6 Menu Description (Square)

2.6 App Connection

Connect the device to the HIKMICRO Sight app via hotspot, then you can capture picture, record video, or configure parameters on your phone.

Before You Start

Confirm **Remote Access** is enabled on the device. Hold  to enter the menu, and go to **Advanced Settings > Remote Access**.

Steps









1. Search for HIKMICRO Sight on App Store (iOS System) or Google Play™ (Android System) to download it, or scan the QR code to download and install the app.



Android System



iOS System

2. Hold  to show the menu.
3. Go to  **Advanced Settings**, and press  or  to select .
4. Press  to enter the setting interface.
5. Press  or  to select **Hotspot_5G** or **Hotspot_2.4G**. The hotspot function is enabled.
 - Use 2.4 GHz if your smartphone does not support 5 GHz.
 - 5 GHz is recommended for small-range scenarios within 5 m, such as mounting device on the vehicle. Otherwise, use 2.4 GHz.
6. Turn on the WLAN of your phone and connect to the hotspot.

- Hotspot Name: HIKMICRO_Serial No.
 - Hotspot Password: Go to **Hotspot** in the menu to check the password.
7. Open the app, and confirm the connection PIN code on the device to connect your phone with the device. You can view the interface of device on your phone.



Note

- When the device is connected to your phone, you can change the hotspot password via the HIKMICRO Sight app.
 - The hotspot password will be updated when you reset the device (refer to *Reset Device*). In this case, you need to reconnect to the device hotspot.
-

2.7 Firmware Status

2.7.1 Check Firmware Status

Steps

1. Open the HIKMICRO Sight and connect your device to the app.
2. Check if there is an upgrade prompt on the device management interface. If there is no upgrade prompt, the firmware is the latest version. Otherwise, the firmware is not the latest version.

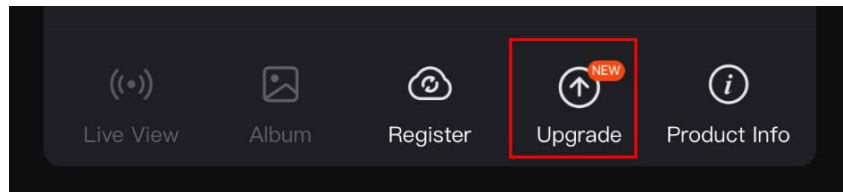

Figure 2-7 Check Firmware Status

3. (Optional) If the firmware is not the latest version, upgrade the device. See *Upgrade Device*.

2.7.2 Upgrade Device

Upgrade Device via HIKMICRO Sight

Steps

1. Open HIKMICRO Sight app and connect your device to the app.
2. Tap the upgrade prompt to enter the firmware upgrade interface.
3. Tap **Upgrade** to start upgrade.



Note









The upgrading operation may vary due to app updates. Please take the actual app version for reference.

Upgrade Device via PC

Before You Start

Please get the upgrade package first.

Steps

1. Hold  to show the menu.
2. Go to  **Advanced Settings**, and press  or  to select .
3. Press  to enter the configuration interface.
4. Press  or  to select **USB Flash Drive**.
5. Connect the device to your PC with cable.
6. Open the detected disk, copy the upgrade file and paste it to the root directory of the device.
7. Disconnect the device from your PC.
8. Reboot the device, and the device upgrades automatically. The upgrading process will be displayed in the main interface.



Caution

During the upgrade package transmission, make sure the device is connected to your PC. Otherwise, it may cause unnecessary upgrade failure, firmware damage, etc.

3 Image Settings

You can set palettes, brightness, scenes, and DPC (defective pixel correction) to display the better image effect.

3.1 Adjust Diopter

Make sure the eyepiece covers your eye and aim at the target. Adjust the diopter adjustment ring until the OSD text or image is clear.

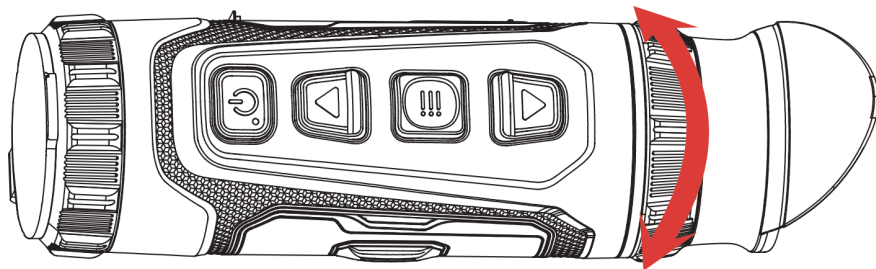

Figure 3-1 Adjust Diopter



Note

When adjusting diopter, DO NOT touch the surface of lens to avoid smearing the lens.

3.2 Adjust Focus

Slightly rotate the focus ring to adjust the focus of the objective lens.

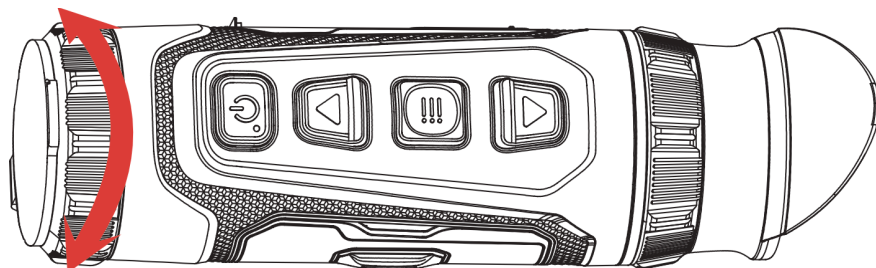

Figure 3-2 Adjust Focus



Note

- When focusing, do not touch the surface of lens to avoid smearing the lens.
 - This function varies according to different camera models.
-

3.3 Adjust Brightness

You can adjust the display brightness of the screen in the menu.

Steps

1. Hold ☰ to show the menu.
2. Press ▲ or ▼ to select ☀ and press ☰ to confirm.
3. Press ▲ or ▼ to adjust display brightness.
4. Hold ☰ to save settings and exit.

3.4 Adjust Contrast

Steps

1. Hold ☰ to show the menu.
2. Press ▲ or ▼ to select 📊 and press ☰ to confirm.
3. Press ▲ or ▼ to adjust contrast.
4. Hold ☰ to save settings and exit.

3.5 Adjust Tone

Steps

1. Hold ☰ to show the menu.
2. Press ▲ or ▼ to select 🌐 and press ☰ to confirm.
3. Press ▲ or ▼ to select a tone. **Cold** and **Warm** can be selected.
4. Hold ☰ to save and exit.



Cold











Warm

Figure 3-3 Adjust Tone

3.6 Adjust Sharpness

Steps

1. Hold  to show the menu.
2. Press  or  to select  and press  to confirm.
3. Press  or  to adjust sharpness.
4. Hold  to save and exit.

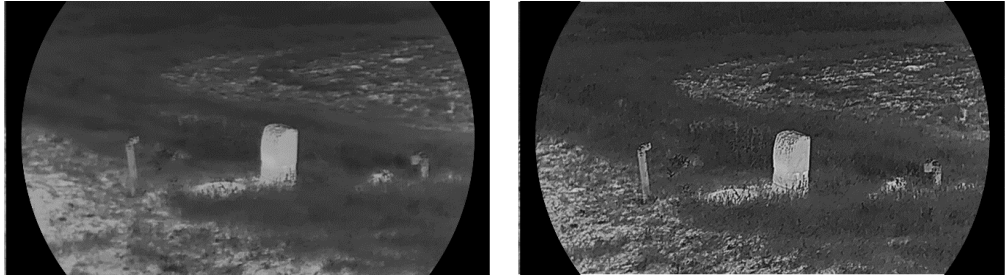











Figure 3-4 Sharpness Adjustment Comparison

3.7 Select Scene

You can select proper scene according to actual using scene to improve the display effect.

Steps

1. Hold  to show the menu.
2. Go to  **Advanced Settings**, and press  or  to select .
3. Press  to enter the setting interface.
4. Press  or  to switch scene.
 - **Observation:** Observation mode is recommended in normal scene.
 - **Detection:** Detection mode is recommended in hunting environment.
5. Hold  to save settings and exit.









3.8 Set Palettes

You can select different palettes to display the same scene in different effects.

3.8.1 Custom Enabled Palettes

Steps

1. Hold  to show the menu.

2. Go to  **Advanced Settings**, and press  or  to select .
3. Press  to enter the settings interface.
4. Press  or  to select the palettes as needed, and press  to enable them.



Note

At least one palette should be enabled.

5. Hold  to save the settings and exit.

3.8.2 Switch Palettes

Press  in the live view interface to switch the selected palettes.

White Hot

The hot part is light-colored in view. The higher the temperature is, the lighter the color is.



Black Hot

The hot part is black-colored in view. The higher the temperature is, the darker the color is.



Fusion

From high temperature to low temperature, the image is colored in from white, yellow, red, pink to purple.



Red Hot

The hot part is red-colored in view. The higher the temperature is, the redder the color is.



Red Monochrome

The whole image is red colored. The higher the temperature is, the lighter the color is.



Green Monochrome

The whole image is green colored. The higher the temperature is, the lighter the color is.



3.9 Set Picture in Picture Mode

Steps







1. Hold  to show the menu.
2. Go to  **Advanced Settings**, and press  or  to select .
3. Press  to enable or disable PIP mode. The details show in the upper center of the view.
4. Hold  to save the settings and exit.



Figure 3-5 Set PIP Mode



Note

- If the PIP function is enabled, only the PIP view zooms when adjusting the digital zoom ratio.
 - The PIP view temporarily displays the zoom ratio when adjusting the digital zoom of the device.
-

3.10 Adjust Digital Zoom

You can zoom in and out the image by using this function. Press ∇ in the live view interface, the digital zoom ratio switches between 1x, 2x, 4x and 8x.







Note





- When switching the digital zoom ratio, the left interface displays the actual magnification (Actual Magnification = Lens Optical Magnification \times Digital Zoom Ratio). For example, the lens optical magnification is 2.8x and the digital zoom ratio is 2x, and the actual magnification is 5.6x.
 - The zoom ratio may vary according to different models. Please take the actual product for reference.
-

3.11 Correct Defective Pixel

The device can correct the defective pixels on the screen which are not performed as expected.

Steps

1. Hold  to show the menu.
 2. Go to  **Advanced Settings**, and press \triangle or ∇ to select .
 3. Press  to enter DPC configuration interface.
-

4. Press  to select **X or Y Axis**. If you select **X axis**, the cursor moves left and right; if you select **Y axis**, the cursor moves up and down.
5. Press  or  to set the coordinates until the cursor reaches the defective pixel.
6. Press  twice to correct the dead pixel.
7. Hold  to save the settings and exit.

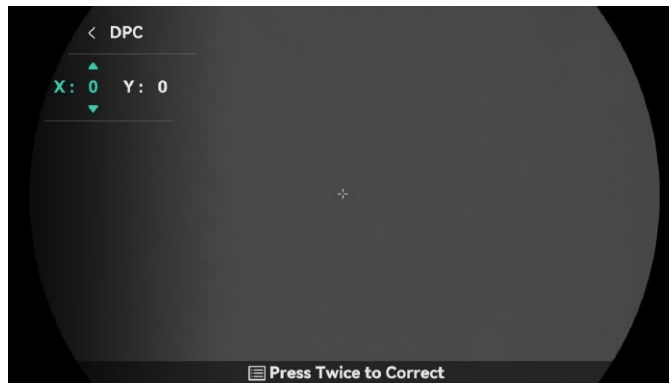

Figure 3-6 Correct Defective Pixel



Note

- The selected defective pixel can be magnified and displayed on the bottom right of the interface.
 - If the screen OSD blocks the defective pixel, move the cursor to reach the defective pixel, then the device performs mirror display automatically.
-













4 Measure Distance

The device can detect the distance between the target and the observation position.

Before You Start

When measuring the distance, keep the hand and the position steady. Otherwise, the accuracy may be affected.



Steps

1. Hold  to show the menu.
2. Go to  **Advanced Settings**, and  or  to select .
3. Press  to enter the setting interface.
4. Set the parameters for the target.
 - 1) Press  to enter the setting interface. Press  or  to select the target from **Grey Wolf**, **Brown Bear**, **Deer**, and **Custom**.
 - 2) Press  to enter target height configuration interface. Press  to select digit, and press  or  to change the number.



Note

The available height ranges from 0.1 m to 9.0 m.

- 3) Hold  to save the settings and return to the distance measurement interface.
5. Align the center of top mark with the edge of target top, and press  to confirm.
6. Align the center of bottom mark with the edge of target bottom, and press  to confirm.

Result

The right top of the image displays the distance measurement result and the height of the target.













Figure 4-1 Measurement Result

5 General Settings

5.1 Set OSD

This function can display or hide the OSD information on the live view interface.

Steps

1. Hold  to show the menu.
2. Go to  **Advanced Settings**, and press  or  to select .
3. Press  to enter OSD setting interface.
4. Press  or  to select the **Time, Date, or OSD**, and press  to turn on or turn off the selected OSD information.
5. Hold  to save and exit.









Note

If you turn off OSD, all OSD information on the live view will not be displayed.

5.2 Set Brand Logo

You can add brand logo to the live view interface, snapshots, and videos.

Steps

1. Hold  to show the menu.
2. Go to  **Advanced Settings**, and press  or  to select .
3. Press  to enable **Brand Logo**.
4. Hold  to save the settings and exit.

Result

The brand logo is displayed at the bottom left of the image.









5.3 Set Screen Style

The device supports both round and square screen styles, which can be selected based on user needs.



The screen style setting may vary according to different models. Please take the actual product for reference.







Steps

1. Hold  to show the menu.
2. Go to  **Advanced Settings**, and press  or  to select .
3. Press  or  to switch screen style. **Round** and **Square** are selectable.
4. Press  to confirm settings according to the prompt.

5.4 Burning Prevention

Avoid direct sunlight and enable the burning prevention function to reduce the risk of sensor damage from the heat.

Steps

1. Hold  to show the menu.
2. Go to  **Advanced Settings**, and press  or  to select .
3. Press  to enable or disable the function.
4. Hold  to save settings and exit.

5.5 Capture and Video

5.5.1 Capture Picture

In the live view interface, press  to capture picture.









Note

- When capturing succeeds, the image freezes for 1 second and a prompt shows on the display.
 - For exporting pictures, refer to *Export Files*.
-

5.5.2 Set Audio

If you turn on the audio function, the sound will be recorded with the video. When there is too loud noise in the video, you can turn off this function.

Steps

1. Hold  to show the menu.
2. Go to  **Advanced Settings**, and press  or  to select .
3. Press  to enable or disable this function.
4. Hold  to save settings and exit.

5.5.3 Record Video

Steps



1. In the live view interface, hold  to start recording.



Figure 5-1 Start Recording





The left image displays the information of recording time.

2. Hold  again to stop recording.

5.5.4 View Local Files

Captured images and recorded videos are automatically stored in the device, and you can view the files in local albums.

Steps

1. Hold  to show the menu.
2. Go to  **Advanced Settings**, and press  or  to select .



Note

The albums are automatically created and named by year + month. The local pictures and videos of a certain month are stored in the corresponding album. For example, the pictures and videos of August in 2025 are saved in the album named 202508.

3. Press \triangle or ∇ to select the album storing the files, and press \equiv to enter the selected album.
4. Press \triangle or ∇ to select a file to view.
5. Press \equiv to view the selected file and relevant information.





Note

- Files are arranged in chronological order, with the most recent at the top. If you fail to find the most recently taken snapshots or videos, please check the time and date settings of your device. When you view files, you can switch to other files by pressing \triangle or ∇ .
 - When you are viewing videos, you can press \equiv to play or stop the video.
 - For deleting an album or a file, you can press $\triangle+\equiv$ to call the dialogue box, and delete the album or file according to the prompt.
-

5.6 Hot Tracking

The device can detect the highest temperature spot in the scene and mark it on display.

Steps

1. Hold \equiv to show the menu.
2. Go to  **Advanced Settings**, and press \triangle or ∇ to select .
3. Press \equiv to mark the spot of highest temperature.

Result



When the function is enabled,  displays in the spot of highest temperature. When the scene changes, the  moves.



Figure 5-2 Hot Tracking

5.7 Export Files

5.7.1 Export Files via HIKMICRO Sight

You can access device albums and export files to your phone via HIKMICRO Sight.

Before You Start

Install HIKMICRO Sight on your mobile phone.

Steps

1. Open HIKMICRO Sight and connect your device to the app. See *App Connection*.
2. Tap **Media** to access device albums.

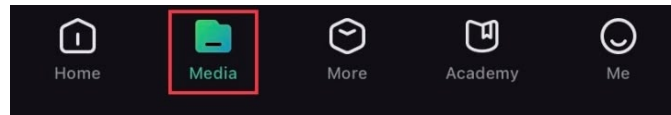

Figure 5-3 Access Device Albums

3. Tap **Local** or **Device** to view the photos and videos.
 - **Local**: You can view the files captured on app.
 - **Device**: You can view the files of the current device.



Note

The photos or videos may not show in **Device**. Please pull down to refresh the page.

4. Tap to select a file, and tap **Download** to export the file to your local phone albums.



Figure 5-4 Export Files



Note

- Go to **Me** -> **About** -> **User Manual** on the app to see more detailed operations.
 - You can also access device albums by tapping bottom left icon in the live view interface.
 - The exporting operation may vary due to app updates. Please take the actual app version for reference.
-









5.7.2 Export Files via PC

This function is used to export recorded videos and captured pictures.

Before You Start

Make sure the device is turned on when connecting the cable.

Steps

1. Hold  to show the menu.
2. Go to  **Advanced Settings**, and press  or  to select .
3. Press  to enter the configuration interface.
4. Press  or  select **USB Flash Drive**.
5. Connect the device and PC with cable.



Note

Make sure the device is turned on when connecting the cable.

6. Open computer disk and select the disk of device. Go to the DCIM folder and find the folder named after the capture year and month. For example, if you capture a picture or record a video on August 2025, go to **DCIM -> 202508** to find the picture or video.
7. Select and copy the files to PC.
8. Disconnect the device from your PC.













Note

- The device displays images when you connect it to PC. But functions such as recording, capturing and hotspot are disabled.
 - When you connect the device to PC for the first time, it installs the drive program automatically.
-

6 System Settings















6.1 Adjust Date

Steps

1. Hold  to show the menu.
2. Go to  **Advanced Settings**, and press  or  to select .
3. Press  to enter the configuration interface.
4. Press  to select the year, month, or day, and press  or  to change the number.
5. Hold  to save settings and exit.

6.2 Synchronize Time











Step

1. Hold  to show the menu.
2. Go to  **Advanced Settings**, and press  or  to select .
3. Press  to enter the configuration interface.
4. Press  or  to switch the clock system. 24-hour and 12-hour clock are selectable. If you select 12-hour clock, press , and then press  or  to select AM or PM.
5. Press  to select the hour or minute, and press  or  to change the number.
6. Hold  to save settings and exit.

6.3 Set Language

You can select the device language in this function.









Steps

1. Hold  to show the menu.
2. Go to  **Advanced Settings**, and press  or  to select .
3. Press  to enter the configuration interface.
4. Press  or  to select the language as required, and press  to confirm.
5. Hold  to save settings and exit.

6.4 Cast Device Screen to PC

The device supports casting screen to PC via a UVC protocol-based streaming media player. You can view the device image on the PC display for details.









Steps

1. Hold  to show the menu.
2. Go to  **Advanced Settings**, and press  or  to select .
3. Press  to enter the configuration interface.
4. Press  or  to select **Digital**.
5. Hold  to save the settings and exit.
6. Open the UVC protocol-based player, and connect your device to the PC via the type-C cable.

6.5 Set Unit

You can switch the unit for distance measurement.

Steps







1. Hold  to show the menu.
2. Go to  **Advanced Settings**, and press  or  to select .
3. Press  to enter the configuration interface.
4. Press  or  to select the unit as required.
5. Hold  to save settings and exit.





6.6 Set Screen Lock Passcode

You can set a passcode to lock the device screen to avoid unauthorized access to the device.





6.6.1 Enable Passcode

Steps

1. Hold  to show the menu.
2. Go to  **Advanced Settings**, and press  or  to select .
3. Press  to enable this function and enter the configuration interface.

4. Press  to switch digit, and press  or  to change the number.
5. Hold  to save settings and exit.

Result

When passcode is enabled, you need to enter the passcode when the device is powered on or woken up from standby mode. Press  to switch digit, press  or  to change the number, and hold  to confirm.















Note

If you forget the passcode, you can hold  to reset it on the lock screen. This operation requires a factory reset to the device.

6.6.2 Change Passcode







You can change the passcode as needed when it is enabled.

Steps

1. Hold  to show the menu.
2. Go to  **Advanced Settings**, and press  or  to select .
3. Press , and then select . Press  to enter the configuration interface.
4. Press  to switch digit, and press  or  to change the number.
5. Hold  to save settings and exit.

6.7 View Device Information







Steps

1. Hold  to show the menu.
2. Go to  **Advanced Settings**, and press  or  to select .
3. Press  to confirm. You can view the device information such as version, available storage space, and serial No.
4. Hold  to save settings and exit.

6.8 Restore Device

This function only restores the device basic settings, such as brightness, contrast, and PIP, to their defaults.







Steps

1. Hold  to show the menu.
2. Go to  **Advanced Settings**, and press  or  to select .
3. Press  to restore the device to defaults according to the prompt.

6.9 Reset Device

This function erases all content and settings, including basic settings, storage, passcode, and hotspot password.

Steps

1. Hold  to show the menu.
2. Go to  **Advanced Settings**, and press  or  to select .
3. Press  to restore the device to defaults according to the prompt.

7 Frequently Asked Questions

7.1 Why does the charge indicator flash improperly?

Check the following items.

- Check whether the device is charged with standard power adapter and the charging temperature is above 0 °C (32 °F).
- Charge the device in power off status.

7.2 Why is the power indicator off?

Check whether the device is off-battery. Check the indicator after charging the device for 5 minutes.

7.3 The image is not clear, how to adjust it?

Adjust the diopter adjustment ring or focus ring until the image is clear. Refer to *Adjust Diopter* or *Adjust Focus*.

7.4 Capturing or recording fails. What's the problem?

Check the following items.

- Whether the device is connected to your PC. Capturing or recording is disabled in this status.
- Whether the storage space is full.
- Whether the device is low-battery.

7.5 Why the PC cannot identify the device?

Check the following items.

- Whether the device is connected to your PC with supplied USB cable.
- If you use other USB cables, make sure the cable length is no longer than 1 m.
- Whether the USB connection mode of device is set to **USB Flash Drive**.

Legal Information

© Hangzhou Microimage Software Co., Ltd. All rights reserved.

About this Manual

The Manual includes instructions for using and managing the Product. Pictures, charts, images and all other information hereinafter are for description and explanation only. The information contained in the Manual is subject to change, without notice, due to firmware updates or other reasons. Please find the latest version of this Manual at the HIKMICRO website (www.hikmicrotech.com/).

Please use this Manual with the guidance and assistance of professionals trained in supporting the Product.

Trademarks Acknowledgement

 **HIKMICRO** and other HIKMICRO's trademarks and logos are the properties of HIKMICRO in various jurisdictions.

Other trademarks and logos mentioned are the properties of their respective owners.

LEGAL DISCLAIMER

TO THE MAXIMUM EXTENT PERMITTED BY APPLICABLE LAW, THIS MANUAL AND THE PRODUCT DESCRIBED, WITH ITS HARDWARE, SOFTWARE AND FIRMWARE, ARE PROVIDED "AS IS" AND "WITH ALL FAULTS AND ERRORS". HIKMICRO MAKES NO WARRANTIES, EXPRESS OR IMPLIED, INCLUDING WITHOUT LIMITATION, MERCHANTABILITY, SATISFACTORY QUALITY, OR FITNESS FOR A PARTICULAR PURPOSE. THE USE OF THE PRODUCT BY YOU IS AT YOUR OWN RISK. IN NO EVENT WILL HIKMICRO BE LIABLE TO YOU FOR ANY SPECIAL, CONSEQUENTIAL, INCIDENTAL, OR INDIRECT DAMAGES, INCLUDING, AMONG OTHERS, DAMAGES FOR LOSS OF BUSINESS PROFITS, BUSINESS INTERRUPTION, OR LOSS OF DATA, CORRUPTION OF SYSTEMS, OR LOSS OF DOCUMENTATION, WHETHER BASED ON BREACH OF CONTRACT, TORT (INCLUDING NEGLIGENCE), PRODUCT LIABILITY, OR OTHERWISE, IN CONNECTION WITH THE USE OF THE PRODUCT, EVEN IF HIKMICRO HAS BEEN ADVISED OF THE POSSIBILITY OF SUCH DAMAGES OR LOSS.

YOU ACKNOWLEDGE THAT THE NATURE OF THE INTERNET PROVIDES FOR INHERENT SECURITY RISKS, AND HIKMICRO SHALL NOT TAKE ANY RESPONSIBILITIES FOR ABNORMAL OPERATION, PRIVACY LEAKAGE OR OTHER DAMAGES RESULTING FROM CYBER-ATTACK, HACKER ATTACK, VIRUS INFECTION, OR OTHER INTERNET SECURITY RISKS; HOWEVER, HIKMICRO WILL PROVIDE TIMELY TECHNICAL SUPPORT IF REQUIRED.

Thermal Monocular User Manual

YOU AGREE TO USE THIS PRODUCT IN COMPLIANCE WITH ALL APPLICABLE LAWS, AND YOU ARE SOLELY RESPONSIBLE FOR ENSURING THAT YOUR USE CONFORMS TO THE APPLICABLE LAW. ESPECIALLY, YOU ARE RESPONSIBLE, FOR USING THIS PRODUCT IN A MANNER THAT DOES NOT INFRINGE ON THE RIGHTS OF THIRD PARTIES, INCLUDING WITHOUT LIMITATION, RIGHTS OF PUBLICITY, INTELLECTUAL PROPERTY RIGHTS, OR DATA PROTECTION AND OTHER PRIVACY RIGHTS. YOU SHALL NOT USE THIS PRODUCT FOR ILLEGAL HUNTING ANIMALS, INVASION OF PRIVACY OR ANY OTHER PURPOSE WHICH IS ILLEGAL OR DETRIMENTAL TO THE PUBLIC INTEREST. YOU SHALL NOT USE THIS PRODUCT FOR ANY PROHIBITED END-USES, INCLUDING THE DEVELOPMENT OR PRODUCTION OF WEAPONS OF MASS DESTRUCTION, THE DEVELOPMENT OR PRODUCTION OF CHEMICAL OR BIOLOGICAL WEAPONS, ANY ACTIVITIES IN THE CONTEXT RELATED TO ANY NUCLEAR EXPLOSIVE OR UNSAFE NUCLEAR FUEL-CYCLE, OR IN SUPPORT OF HUMAN RIGHTS ABUSES.

IN THE EVENT OF ANY CONFLICTS BETWEEN THIS MANUAL AND THE APPLICABLE LAW, THE LATTER PREVAILS.

Regulatory Information

These clauses apply only to the products bearing the corresponding mark or information.

EU Conformity Statement



This product and - if applicable - the supplied accessories too are marked with "CE" and comply therefore with the applicable harmonized European standards listed under the Directive 2014/30/EU (EMCD), Directive 2014/35/EU (LVD), Directive 2011/65/EU (RoHS), Directive 2014/53/EU. Hereby, Hangzhou Microimage Software Co., Ltd. declares that this device (refer to the label) is in compliance with Directive 2014/53/EU.

The full text of the EU declaration of conformity is available at the following internet address:

<https://www.hikmicrotech.com/en/support/download-center/declaration-of-conformity/>

Frequency Bands and Power (for CE)

The frequency bands and transmitting power (radiated and/or conducted) nominal limits applicable to the following radio equipment are as follows:

Wi-Fi 2.4 GHz (2.4 GHz to 2.4835 GHz): 20 dBm;

5 GHz (5.15 GHz to 5.25 GHz): 23 dBm

5.15~5.25 GHz 屋内使用のみ。

For the device without a supplied power adapter, use the power adapter provided by a qualified manufacturer. Refer to the product specification for detailed power requirements.

For the device without a supplied battery, use the battery provided by a qualified manufacturer. Refer to the product specification for detailed battery requirements.



Directive 2012/19/EU (WEEE Directive): Products marked with this symbol cannot be disposed of as unsorted municipal waste in the European Union. For proper recycling, return this product to your local supplier upon the purchase of equivalent new equipment, or dispose of it at designated collection points. For more information see: www.recyclethis.info



Regulation (EU) 2023/1542 (Battery Regulation): This product contains a battery and it is in conformity with the Regulation (EU) 2023/1542. The battery cannot be



disposed of as unsorted municipal waste in the European Union. See the product documentation for specific battery information. The battery is marked with this symbol, which may include lettering to indicate cadmium (Cd), or lead (Pb). For proper recycling, return the battery to your supplier or to a designated collection point. For more information see: www.recyclethis.info.

INFORMATIONEN FÜR PRIVATE HAUSHALTE

1. Getrennte Erfassung von Altgeräten:

Elektro- und Elektronikgeräte, die zu Abfall geworden sind, werden als Altgeräte bezeichnet. Besitzer von Altgeräten haben diese einer vom unsortierten Siedlungsabfall getrennten Erfassung zuzuführen. Altgeräte gehören insbesondere nicht in den Hausmüll, sondern in spezielle Sammel- und Rückgabesysteme.

2. Batterien und Akkus sowie Lampen:

Besitzer von Altgeräten haben Altbatterien und Altakkumulatoren, die nicht vom Altgerät umschlossen sind, die zerstörungsfrei aus dem Altgerät entnommen werden können, im Regelfall vor der Abgabe an einer Erfassungsstelle vom Altgerät zu trennen. Dies gilt nicht, soweit Altgeräte einer Vorbereitung zur Wiederverwendung unter Beteiligung eines öffentlich-rechtlichen Entsorgungsträgers zugeführt werden.

3. Möglichkeiten der Rückgabe von Altgeräten:

Besitzer von Altgeräten aus privaten Haushalten können diese bei den Sammelstellen der öffentlich-rechtlichen Entsorgungsträger oder bei den von Herstellern oder Vertriebern im Sinne des ElektroG eingerichteten Rücknahmestellen unentgeltlich abgeben. Rücknahmepflichtig sind Geschäfte mit einer Verkaufsfläche von mindestens 400 m² für Elektro- und Elektronikgeräte sowie diejenigen Lebensmittelgeschäfte mit einer Gesamtverkaufsfläche von mindestens 800 m², die mehrmals pro Jahr oder dauerhaft Elektro- und Elektronikgeräte anbieten und auf dem Markt bereitstellen. Dies gilt auch bei Vertrieb unter Verwendung von Fernkommunikationsmitteln, wenn die Lager- und Versandflächen für Elektro- und Elektronikgeräte mindestens 400 m² betragen oder die gesamten Lager- und Versandflächen mindestens 800 m² betragen. Vertrieber haben die Rücknahme grundsätzlich durch geeignete Rückgabemöglichkeiten in zumutbarer Entfernung zum jeweiligen Endnutzer zu gewährleisten. Die Möglichkeit der unentgeltlichen Rückgabe eines Altgerätes besteht bei rücknahmepflichtigen Vertriebern unter anderem dann, wenn ein neues gleichartiges Gerät, das im Wesentlichen die gleichen Funktionen erfüllt, an einen Endnutzer abgegeben wird.

4. Datenschutz-Hinweis:

Altgeräte enthalten häufig sensible personenbezogene Daten. Dies gilt insbesondere für Geräte der Informations- und Telekommunikationstechnik wie Computer und Smartphones. Bitte beachten Sie in Ihrem eigenen Interesse, dass für die Löschung der Daten auf den zu entsorgenden Altgeräten jeder Endnutzer selbst verantwortlich ist.



5. Bedeutung des Symbols „durchgestrichene Mülltonne“:



Das auf Elektro- und Elektronikgeräten regelmäßig abgebildete Symbol einer durchgestrichenen Mülltonne weist darauf hin, dass das jeweilige Gerät am Ende seiner Lebensdauer getrennt vom unsortierten Siedlungsabfall zu erfassen ist.

Symbol Conventions

The symbols that may be found in this document are defined as follows.

Symbol	Description
 Note	Provides additional information to emphasize or supplement important points of the main text.
 Caution	Indicates a potentially hazardous situation, which if not avoided, could result in equipment damage, data loss, performance degradation, or unexpected results.
 Danger	Indicates a hazard with a high level of risk, which if not avoided, will result in death or serious injury.

Safety Instruction

These instructions are intended to ensure that user can use the product correctly to avoid danger or property loss. Please read all the safety information carefully before using.

Laws and Regulations

Use of the product must be in strict compliance with the local electrical safety regulations.

Transportation

- Keep the device in original or similar packaging while transporting it.
- Keep all wrappers after unpacking them for future use. In case of any failure occurred, you need to return the device to the factory with the original wrapper.
- Transportation without the original wrapper may result in damage on the device and the company shall not take any responsibilities.
- Do not drop the product or subject it to physical shock. Keep the device away from magnetic interference.

Power Supply

- If a power adapter is provided in the device package, use the provided adapter only. If no power adapter is provided, ensure the power adapter or other power supply complies with Limited Power Source. Refer to the product label for the power supply output parameters.
- The power delivered by the charger must be between min. 5 Watts required by the radio equipment, and max. 10 Watts in order to achieve the maximum charging speed.
- Make sure the plug is properly connected to the power socket.
- DO NOT connect multiple devices to one power adapter, to avoid overheating or fire hazards caused by overload.

Battery

- The external rechargeable battery type is 18650, and the battery size should be 19 mm × 70 mm. The rated voltage is 3.635 VDC, and the battery capacity is 3300 mAh.
- For long-term storage of the battery, make sure it is fully charged every 3 months to ensure the battery quality. Otherwise, damage may occur.
- CAUTION: Risk of explosion if the battery is replaced by an incorrect type. Replace with the same or equivalent type only.
- Improper replacement of the battery with an incorrect type may defeat a safeguard (for example, in the case of some lithium battery types).
- Do not dispose of the battery into fire or a hot oven, or mechanically crush or cut the battery, which may result in an explosion.
- Do not leave the battery in an extremely high temperature surrounding

environment, which may result in an explosion or the leakage of flammable liquid or gas.

- Do not subject the battery to extremely low air pressure, which may result in an explosion or the leakage of flammable liquid or gas.
- Dispose of used batteries according to the instructions.
- Confirm there is no flammable material within 2 m of the charger during charging.
- DO NOT place the battery in the reach of children.
- DO NOT swallow the battery to avoid chemical burns.
- Batteries of improper size cannot be installed, and may cause abnormal shutdown.
- Please purchase the batteries recommended by the manufacturer if necessary.
- The purchased batteries by users need to comply with the relevant international standards about battery safety (e.g. EN/IEC standards).
- Use the battery provided by qualified manufacturer. Refer to the product specification for detailed battery requirements.
- CAUTION: Risks of short circuit, fire, or explosion if the battery is damaged. Frequent use, dropping, impact, corrosion, or compression of the battery may cause damages including cracked casing, detached plates, or leakage of internal liquid or gas, etc.
- If the battery is damaged, stop using it immediately and dispose of it according to the instructions.
- Remove the battery if you do not use the device for a long time.
- Make sure the battery temperature is between 0°C to 55°C (32°F to 131°F) when charging.
- DO NOT place the device with battery or the battery alone near heating or fire source. Avoid direct sunlight.
- This product contains a coin/button cell battery. If the coin/button cell battery is swallowed, it can cause severe internal burns in just 2 hours and can lead to death.
- If the battery compartment does not close securely, stop using the product and keep it away from children.
- If you think batteries might have been swallowed or placed inside any part of the body, seek immediate medical attention.
- This device is not suitable for use in locations where children are likely to be present.

Maintenance

- If the product does not work properly, please contact your dealer or the nearest service center. We shall not assume any responsibility for problems caused by unauthorized repair or maintenance.
- Make sure that the power has been disconnected before device teardown and repair by professionals.
- Check the optical surfaces of objective lens, eyepiece, rangefinder, etc. If necessary, remove dust and sand from the optics using tools and

solvent designed especially for this purpose (it is preferable to use a non-contact method).

- Wipe the exterior surfaces of metal, plastic and silicone parts with a clean and soft cloth. Do not use chemically active substances, solvents, etc. as these may damage the paint.
- Clean the electrical contacts of the battery on the device using a non-greasy organic solvent.
- If the equipment is used in a manner not specified by the manufacturer, the protection provided by the device may be impaired.

Using Environment

- Make sure the running environment meets the requirement of the device. The operating temperature shall be -30 °C to 45 °C (-22 °F to 113 °F), and the operating humidity shall be from 5% to 95%.
- DO NOT expose the device to high electromagnetic radiation or dusty environments.
- DO NOT aim the lens at the sun or any other bright light.
- Place the device in a dry and well-ventilated environment.
- Avoid equipment installation on vibratory surface or places subject to shock (neglect may cause equipment damage).

Emergency

If smoke, odor, or noise arises from the device, immediately turn off the power, unplug the power cable, and contact the service center.

Limited Warranty

Scan the QR code for the product warranty policy.



Manufacture Address

Room 313, Unit B, Building 2, 399 Danfeng Road, Xixing Subdistrict, Binjiang District, Hangzhou, Zhejiang 310052, China

Hangzhou Microimage Software Co., Ltd.

COMPLIANCE NOTICE: The thermal series products might be subject to export controls in various countries or regions, including without limitation, the United States, European Union, United Kingdom and/or other member countries of the Wassenaar Arrangement. Please consult

Thermal Monocular User Manual

your professional legal or compliance expert or local government authorities for any necessary export license requirements if you intend to transfer, export, re-export the thermal series products between different countries.



 Hikmicro Hunting.Global

 HIKMICRO Outdoor

 www.hikmicrotech.com

 Hikmicro Hunting.Global

 HIKMICRO Hunting.Global

 support@hikmicrotech.com